

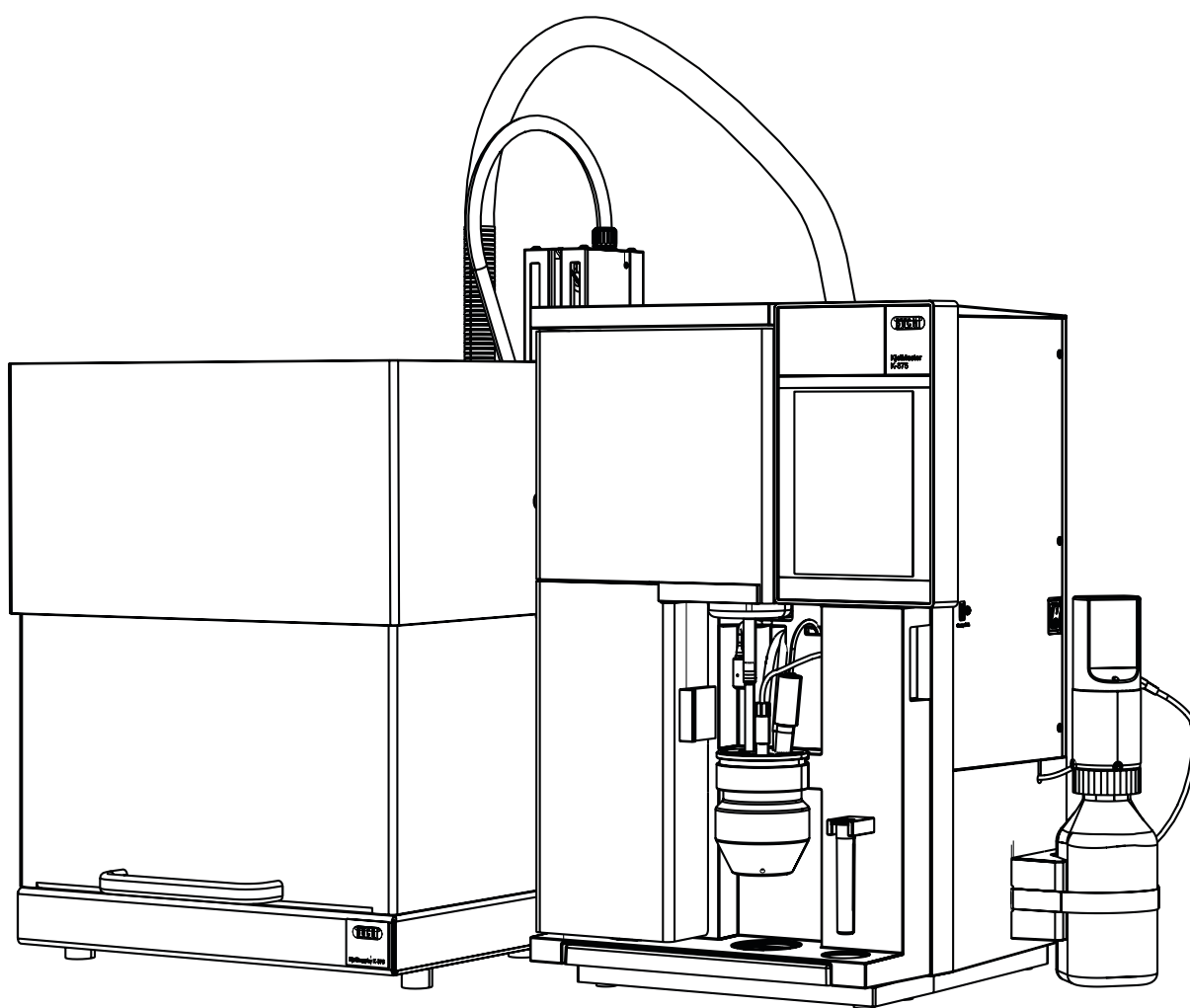

KjelMaster K-375 with KjelSampler K-376 / K-377

Operation Manual



Imprint

Product Identification:
Operation Manual (Original), KjelMaster K-375 with KjelSampler K-376 / K-377

11593514 en

Publication date: 12.2018

BÜCHI Labortechnik AG
Meierseggstrasse 40
Postfach
CH-9230 Flawil 1

E-Mail: quality@buchi.com

BUCHI reserves the right to make changes to the manual as deemed necessary in the light of experience; especially in respect to structure, illustrations and technical detail.

This manual is copyright. Information from it may not be reproduced, distributed, or used for competitive purposes, nor made available to third parties. The manufacture of any component with the aid of this manual without prior written agreement is also prohibited.

Document History

Index	Date	Author	Changes
A	25/MAY/2012	NAGG	Initial version
B	16/JUL/2013	NAGG	First revised version
C	17/NOV/2014	HILS/BRUS	Second revised version (update colorimetric titration)
D	28/APR/2016	HILS	Removal of Declaration of Conformity
E	12/DEC/2018	HOES	Third revised version (update colorimetric titration)

Read this manual carefully before installing and running your system and note the safety precautions in chapter 2 in particular. Store the manual in the immediate vicinity of the instrument, so that it can be consulted at any time. No technical modifications may be made to the device without the prior written agreement of BUCHI. Unauthorized modifications may affect the system safety or result in accidents.

This manual is copyright. Information from it may not be reproduced, distributed, or used for competitive purposes, nor made available to third parties. The manufacture of any component with the aid of this manual without prior written agreement is also prohibited.

If you need another language version of this manual, you can download it at www.buchi.com.

Table of contents

1	About this manual	9
1.1	Trademarks	9
1.2	Abbreviations	9
2	Safety	10
2.1	User qualification	10
2.2	Proper use	10
2.3	Improper use	10
2.4	Safety warnings and safety signs used in this manual	11
2.5	Product safety	12
2.5.1	General hazards	12
2.5.2	Instrument-related hazards	13
2.5.3	Other hazards	14
2.5.4	Personal protective equipment	14
2.5.5	Built-in safety elements and measures	15
2.6	General safety rules	16
3	Technical data	17
3.1	Scope of delivery	17
3.1.1	Basic devices	17
3.1.2	Standard accessories for K-375	19
3.1.3	Standard accessories for K-376 / K-377	21
3.1.4	Operation Manuals for K-375	22
3.1.5	Optional accessories K-375	23
3.1.6	Optional accessories K-376 / K-377	25
3.2	Technical data overview	26
3.2.1	Technical data KjElMaster K-375 and KjElSampler K-376 / K-377	26
3.2.2	Technical data titrator	27
3.3	Determination parameters	28
3.4	Information on type plate	29
3.4.1	Titrator module and dosing unit	29
3.4.2	Material on the K-375	29
3.4.3	Material on the K-376 / K-377	30
4	Description of function	31
4.1	Device overview	31
4.1.1	Opening the service door	32
4.2	Functional principle of KjElMaster System K-375 / K-376 / K-377	33
4.3	Standby function	35
4.4	System preparation	35
4.4.1	Preheating	35
4.4.2	Priming	35
4.4.3	Cleaning	35
4.4.4	Aspiration	35
4.5	Distillation and titration	36
4.5.1	Distillation and Titration Options	36
4.5.2	Distillation Mode	36

4.5.3	Titration Type	36
4.5.4	Sensor Type	36
4.5.5	Titration Mode	37
4.5.6	Measuring Mode	37
4.5.7	Titration Algorithm	37
4.5.8	Determination Mode	37
4.6	Different methods	38
4.7	Blank values	38
4.7.1	Blanks	38
4.7.2	Control blanks	39
4.8	Reference substances	39
4.9	Indicator for colorimetric titration	40
4.10	Result Groups	40
4.11	Explanation of alkaline direct distillation	41
5	Putting into operation	43
5.1	Installation site	43
5.2	Electrical connections	44
5.2.1	Connections of the KjellMaster K-375	44
5.2.2	Connections of the K-376 / K-377	45
5.3	Transfer connection K-376 / K-377 to K-375	46
5.3.1	Connecting the K-376 to the K-375	46
5.3.2	Connecting the transfer hoses of the K-377	48
5.4	Reagent/water and waste connections	49
5.5	Buret unit for titrant	51
5.6	Positioning of the dosing tip	53
5.7	Storage tank connection	53
5.8	Level sensors	54
5.9	Installation of the titration sensor	56
5.9.1	Potentiometric sensor	56
5.9.2	Colorimetric sensor	56
5.10	Connections to peripheral devices	57
5.10.1	Connecting a printer	57
5.10.2	Connecting a network cable	57
5.10.3	Connecting a KjellSampler K-376 or K-377	57
5.10.4	Connecting a balance	57
5.10.5	Connecting a bar code reader	58
5.10.6	External dosing unit for back titration	58
5.11	Preparing the system	58
5.11.1	Preparing the software	58
5.11.2	Preparing the hardware	59
6	Operation	60
6.1	The operating principle	60
6.2	The home screen	60
6.2.1	The title bar	62
6.2.2	The bottom bar	62

6.2.3	System status icons	63
6.3	User concept	63
6.4	Editable and non-editable menu items	63
6.5	The status view	65
6.5.1	RESULT display	66
6.5.2	CHART display	67
6.6	Determination	67
6.6.1	System Preparation	69
	Single Sample	77
6.6.3	Sample Lists	79
6.6.4	Sequences	84
6.7	Results	92
6.7.1	Result groups	92
6.7.2	Last Results	94
6.7.3	Blank Correction	95
6.8	Determination Parameters	99
6.8.1	Methods	99
6.8.2	Volumetric Solutions	108
6.8.3	Reference Substances	109
6.9	Device	110
6.9.1	Settings	110
6.9.2	Utilities	117
6.9.3	Diagnostics	118
6.9.4	Logout	119
7	Maintenance	119
7.1	Daily maintenance	120
7.1.1	Before sample determination (potentiometry)	120
7.1.2	Before sample determination (colorimetry)	121
7.1.3	After sample determination	122
7.1.4	pH electrode	122
7.1.5	Filling boric acid into receiving vessel after last sample of rack was determined (potentiometry only)	123
7.1.6	Sample tube cleaning	124
7.2	Weekly maintenance	125
7.2.1	Cleaning the housing	125
7.2.2	Cleaning the titrator	125
7.2.3	Cleaning the glass parts of the dosing unit	125
7.2.4	Cleaning the dip tube of the KjelSampler	125
7.2.5	Device monitoring	126
7.2.6	Cleaning colorimetric sensor and mesh	127
7.3	Monthly maintenance	127
7.3.1	Calibrating the pump	127
7.3.2	Checking the distillate amount	129
7.3.3	Inspecting the buret	130
7.3.4	Inspecting the titrator	130

7.3.5	Inspecting the sample tubes	130
7.4	Half-yearly maintenance	132
7.4.1	K-375 Sealing between sample tube and splash protector	132
7.4.2	K-376 / K-377 dip tube and sealing cap	133
7.4.3	Replacing the splash protector	134
7.5	Yearly maintenance	136
7.5.1	Replacement of wear parts	136
7.5.2	Decalcification of the steam generator	137
7.5.3	Replacement of the sodium hydroxide pump	137
7.5.3	Replacement of the wave spring	138
7.6	Replace every two years	139
7.6.1	Replacement of the transfer connection	139
7.7	Maintenance work if required	141
7.7.1	Changing the buret tip	141
7.7.2	Cleaning the pH electrode	141
7.7.3	Replacing the buret	142
7.7.4	Cleaning the splash protector and the rubber seal	142
7.7.5	Glass parts	142
7.7.6	Troubleshooting the dosing unit	143
7.7.7	Adjusting the sample tube holder	143
7.8	Customer service	144
8	Troubleshooting	145
8.1	Problems that may occur	145
8.2	Error messages on the display of the K-375	149
8.3	Eliminating errors of the KjelSampler K-376 / K-377	153
8.4	Eliminating errors of the titrator	154
9	Taking out of operation	155
9.1	Emptying the steam generator	155
9.2	Emptying the buret of the titrator	156
9.3	Storage/shipping	156
9.4	Disposal	156
10	Spare parts	157
10.1	Spare parts K-375	157
10.2	Spare parts K-376 / K-377	160
10.3	Hosing connection scheme Kjeldahl Sampler System K-375 / K-376	160
11	Declarations and requirements	161
11.1	FCC requirements (for USA and Canada)	161

1 About this manual

This manual describes the KjelMaster System K-375 / K-376 / K-377 and provides all information required for its safe operation and to maintain it in good working order.

It is addressed to laboratory personnel in particular.

NOTE

The symbols pertaining to safety (DANGER, CAUTION and WARNING) are explained in chapter 2.

1.1 Trademarks

DURAN® is a registered trademark of the SCHOTT AG.

Nylflex® is a registered trademark of the Pedex & Co. GmbH.

1.2 Abbreviations

CSM: Chopped Strand Mat

ETFE: Polytetrafluorethylene

FEP: Fluorinated Ethylene Propylene

KCl: Potassium chloride

PCTFE: Polychlorotrifluoroethylene

PMMA: Polymethyl methacrylate

POM: Polyoxymethylene

PP: Polypropylene

PTFE: Ethylenetetrafluoroethylene

PUR: Polyurethane

UV: Ultraviolet

EPDM: Ethylene propylene diene monomer

PVDF: polyvinylidene difluoride

PA: Polyamides

2 Safety

This chapter points out the safety concept of the device and contains general rules of behavior and warnings from hazards concerning the use of the product.

The safety of users and personnel can only be ensured if these safety instructions and the safety related warnings in the individual chapters are strictly observed and followed. Therefore, the manual must always be available to all persons performing the tasks described herein.

2.1 User qualification

The device may only be used by laboratory personnel and other persons who on account of training or professional experience have an overview of the dangers which can develop when operating the instrument.



Personnel without this training or persons who are currently being trained require careful instruction. The present Operation Manual serves as the basis for this.

2.2 Proper use

The device has been designed and built for laboratories. It serves for nitrogen determination according to Kjeldahl. The KjelMaster K-375 as stand-alone device may also be used for distillations of steam-volatile substances.

2.3 Improper use

Applications not mentioned above are improper. Also applications which do not comply with the technical data are considered improper.

	 Danger
	<p>During any improper use, the effectiveness of the protection systems of the devices can be affected.</p> <ul style="list-style-type: none"> · Avoid any improper use of the devices!

The operator bears the sole risk for any damages caused by such improper use.



The following uses are expressly forbidden:

- Use of the device in rooms which require ex-protected devices.
- Use on samples which can explode or inflame (e.g.: explosives, etc.) due to shock, friction, heat or spark formation.

2.4 Safety warnings and safety signs used in this manual

DANGER, WARNING, CAUTION and NOTICE are standardized signal words for identifying levels of hazard seriousness of risks related to personal injury and property damage. All signal words, which are related to personal injury are accompanied by the general safety sign.

For your safety it is important to read and fully understand the table below with the different signal words and their definitions!

Sign	Signal word	Definition	Risk level
	DANGER	Indicates a hazardous situation which, if not avoided, will result in death or serious injury.	★★★★
	WARNING	Indicates a hazardous situation which, if not avoided, may result in serious injury or death.	★★★☆
	CAUTION	Indicates a hazardous situation which, if not avoided, may result in minor or moderate injury.	★★☆☆
	NOTICE	Indicates possible material damage, but no practices related to personal injury.	☆☆☆☆

Supplementary safety information symbols may be placed in a rectangular panel on the left to the signal word and the supplementary text (see example below).













Space for supplementary safety information symbols.	 SIGNAL WORD
	Supplementary text, describing the kind and level of hazard/risk seriousness. <ul style="list-style-type: none"> · List of measures to avoid the herein described, hazard or hazardous situation. · ... · ...

Table of supplementary safety information symbols





The reference list below incorporates all safety information symbols used in this manual and their meaning.

Warning safety symbols

Symbol	Meaning	Symbol	Meaning
	General warning		Corrosive hazard
	Electrical hazard		Flammable
	Biohazard		Explosive environment
	Broken glass		Inhalation harmful

Symbol	Meaning	Symbol	Meaning
	Device damage		Hot surface
	Hand bruising		Magnet

Mandatory safety symbols

Symbol	Meaning	Symbol	Meaning
	Wear protective goggles		Wear protective clothes
	Wear protective gloves		Heavy load, lift with assistance

Additional user information

Paragraphs starting with NOTE transport helpful information for working with the device/software or its supplementaries. NOTES are not related to any kind of hazard or damage (see following example).

NOTE

Useful tips for the easy operation of the instrument/software.

2.5 Product safety

The device is designed and built in accordance with current state-of-the-art technology. Nevertheless, risks to users, property, and the environment can arise when the device is used carelessly or improperly.

The manufacturer has determined residual dangers emanating from the instrument

if the device is operated by insufficiently trained personnel.



if the device is not operated according to its proper use.

Appropriate warnings in this manual serve to make the user alert to these residual dangers.





2.5.1 General hazards





The following safety messages show hazards of general kind which may occur when handling the instrument. The user shall observe all listed counter measures in order to achieve and maintain the lowest possible level of hazard.

Additional warning messages can be found whenever actions and situations described in this manual are related to situational hazards.

	<p>Danger</p> <p>Death or serious injuries by use in explosive environments.</p> <ul style="list-style-type: none"> Do not store or operate the device in explosive environments. Remove all sources of flammable vapors. Do not store chemicals in the vicinity of the device.
	<p>Caution</p> <p>Risk of minor or moderate cuts by sharp edges.</p> <ul style="list-style-type: none"> Do not touch defective or broken glassware with bare hands. Do not touch thin metal edges.
	<p>Notice</p> <p>Risk of device damage by liquids or mechanical shocks.</p> <ul style="list-style-type: none"> Do not spill liquids over the device or its components. Do not drop the device or its components. Keep external vibrations away from the instrument.

2.5.2 Instrument-related hazards

	<p>CAUTION</p> <p>Risk of injury.</p> <ul style="list-style-type: none"> Never touch the surface of the touch screen with pointed or sharp objects! Otherwise the screen might get damaged and splinter.
	<p>CAUTION</p> <p>Risk of burns by hot surface. Surface temperature exceeds 60 °C.</p> <ul style="list-style-type: none"> Do not touch hot surfaces of the instrument.
	<p>CAUTION</p> <p>Risk of pinch point injuries.</p> <ul style="list-style-type: none"> In order to avoid injuries to the hands and fingers the K-376 and K-377 Kjel-Samplers may not be manipulated during the moving action of the sampler arm.
	<p>CAUTION</p> <p>Risk of burns by hot steam.</p> <ul style="list-style-type: none"> The system works with hot steam. Avoid any contact with hot steam.

   	<p>! DANGER</p> <p>Risk of chemical burns by corrosives.</p> <ul style="list-style-type: none"> · Wear laboratory coat, protective gloves and protective goggles at all times.
	<p>! DANGER</p> <p>Risk of chemical burns by corrosives.</p> <ul style="list-style-type: none"> · During operation the sample tube contains either strong acid or strong base. In case the sample tube breaks, the content of the sample tube is collected in the drip tray on the bottom of the housing. Wear laboratory coat protective gloves and protective goggles when emptying the drip tray.





2.5.3 Other hazards

Fundamental dangers arise from.

- acids and lye
- flammable gases or solvent fumes in the direct vicinity of the instrument
- damaged glass parts
- insufficient distance between the device and the wall (see chapter 5.1, Installation site)
- burns caused by contact with hot glass parts
- burns caused by contact with steam at the waste-outlet
- defective transfer tube: escape of steam and/or sulfuric acid

2.5.4 Personal protective equipment

Always wear personal protective equipment such as protective eye goggles, protective clothing and gloves. The personal protective equipment must meet all requirements of all data sheets for the chemicals used. These instructions are an important part of the K-375, K-376 and K-377 and must be made available at all times to the operating personnel at the place where the equipment is deployed. This also applies to additional language versions of these instructions, which can be reordered separately.

   	<p>! WARNING</p> <p>Serious chemical burns by corrosives.</p> <ul style="list-style-type: none"> · Observe all data sheets of the used chemicals. · Handle corrosives in well ventilated environments only. · Always wear protective goggles. · Always wear protective gloves. · Always wear protective clothes. · Do not use damaged glassware.
---	---

2.5.5 Built-in safety elements and measures

The KjellMaster K-375 has monitored protective doors which prevent a distillation to start while a door is open. A running distillation is immediately interrupted when a door is opened. The dosing of reagents is also immediately stopped.

The sample changers K-376 / K-377 have monitored protective shields. Running a sample changer with opened shield is impossible. For the K-377 only the shield of the tray, that is currently not in use can be opened.

K-375:

- Protective door: Safety appliance to protect users from burns at the splash protector (distillation area) which is hot during distillation.
- Protective door sensors: Prevents to start a distillation with the protective doors open and stops the distillation as soon as a protective door is opened during the process.
- Sample tube sensor: Prevents to start a distillation without a sample tube inserted.
- Service door sensor/switch: Electrical power is disconnected immediately when the service door is opened, thus preventing electrical shock during maintenance.

K-376:

- Protective shield with sensor/switch: As soon as the shield is opened an alarm sound is triggered and any movement of the arm is stopped.

K-377:

- Protective shield with sensor/switch: As soon as the shield of the tray in use is opened an alarm sound is triggered and any movement of the arm is stopped. (The shield of the respective tray that is not operated can still be opened without any restrictions.)

2.6 General safety rules

Responsibility of the operator

The head of the laboratory is responsible for training his/her personnel.

The operator shall inform the manufacturer without delay of any safety-related incidents which might occur during operation of the device or its accessories. Legal regulations, such as local, state and federal laws applying to the device or its accessories must be strictly followed.

Duty of maintenance and care

The operator is responsible for the proper condition of instrument. This includes maintenance, service and repair jobs that are performed on schedule by authorized personnel only.

Spare parts to be used

Use only genuine consumables and spare parts for maintenance to assure good system performance, reliability and safety. Any modifications of spare parts or assemblies are only allowed with the prior written permission of the manufacturer.

Modifications

Modifications to the device are only permitted after prior consultation and with the written approval of the manufacturer. Modifications and upgrades shall only be carried out by an authorized BUCHI technical engineer. The manufacturer will decline any claim resulting from unauthorized modifications.

3 Technical data

This chapter introduces the reader to the device specifications. It contains the scope of delivery, technical data, requirements and performance data.

3.1 Scope of delivery

3.1.1 Basic devices

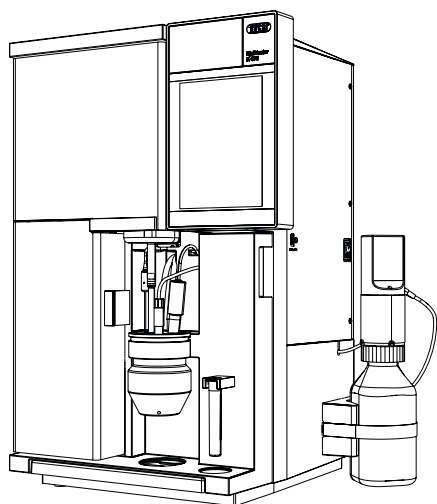

KjelMaster K-375 Order number

KjelMaster K-375 113751700
with **glass** splash protector and
potentiometric sensor
(220 – 240 V, 50/60 Hz)

KjelMaster K-375 113752700
with **glass** splash protector and
colorimetric sensor
(220 – 240 V, 50/60 Hz)

KjelMaster K-375 113753700
with **plastic** splash protector and
potentiometric sensor
(220 – 240 V, 50/60 Hz)

KjelMaster K-375 113754700
with **plastic** splash protector and
colorimetric sensor
(220 – 240 V, 50/60 Hz)

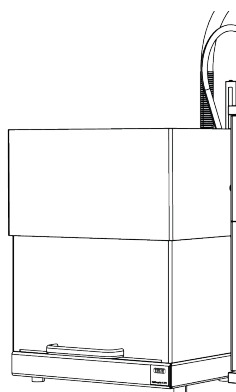

KjelSampler K-376 Order number

KjelSampler K-376 113750710
with **one** tray
(100 – 240 V, 50/60 Hz)

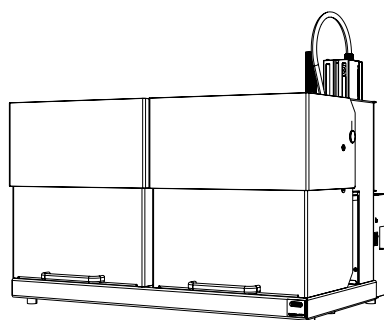

KjelSampler K-377 Order number

KjelSampler K-377 113750720
with **two** trays
(100 – 240 V, 50/60 Hz)

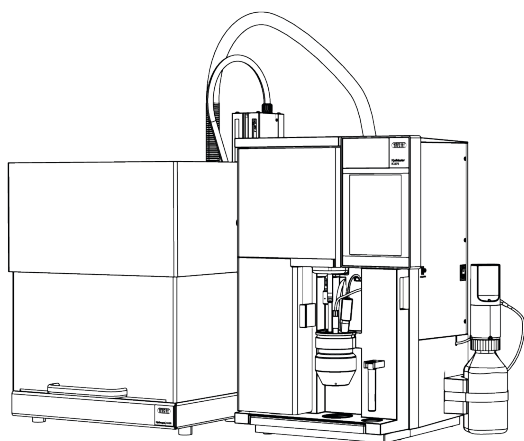

KjelMaster System K-375 / K-376 Order number

KjelMaster System K-375 / K-376 113751710

K-375 with **glass** splash protector and
potentiometric sensor

K-375: 220 – 240 V, 50/60 Hz

K-376 / K-377: 100 – 240 V, 50/60 Hz

KjelMaster System K-375 / K-376 113752710

K-375 with **glass** splash protector and
colorimetric sensor

K-375: 220 – 240 V, 50/60 Hz

K-376 / K-377: 100 – 240 V, 50/60 Hz

KjelMaster System K-375 / K-376 113753710

K-375 with **plastic** splash protector and
potentiometric sensor

K-375: 220 – 240 V, 50/60 Hz

K-376 / K-377: 100 – 240 V, 50/60 Hz

KjelMaster System K-375 / K-376 113754710

K-375 with **plastic** splash protector and
colorimetric sensor

K-375: 220 – 240 V, 50/60 Hz

K-376 / K-377: 100 – 240 V, 50/60 Hz

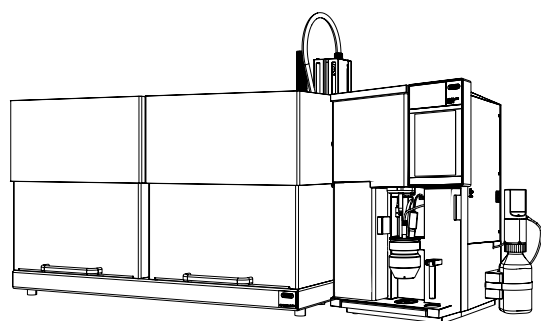

KjelMaster System K-375 / K-377 Order number

KjelMaster System K-375 / K-377 113751720

K-375 with **glass** splash protector and
potentiometric sensor

K-375: 220 – 240 V, 50/60 Hz

K-376 / K-377: 100 – 240 V, 50/60 Hz

KjelMaster System K-375 / K-377 113752720

K-375 with **glass** splash protector and
colorimetric sensor

K-375: 220 – 240 V, 50/60 Hz

K-376 / K-377: 100 – 240 V, 50/60 Hz

KjelMaster System K-375 / K-377 113753720

K-375 with **plastic** splash protector and
potentiometric sensor

K-375: 220 – 240 V, 50/60 Hz

K-376 / K-377: 100 – 240 V, 50/60 Hz

KjelMaster System K-375 / K-377 113754720

K-375 with **plastic** splash protector and
colorimetric sensor

K-375: 220 – 240 V, 50/60 Hz

K-376 / K-377: 100 – 240 V, 50/60 Hz

3.1.2 Standard accessories for K-375

Description	Order number	Picture
Sample tube (300 mL)	—	①
Pair of glass tongs	002004	②
Connection cable RJ45 length 2 m	044989	
Mains cable of the following types		
Type CH	010010	
Type Schuko/Japan	010016	
Type GB	017835	
Type AUS	017836	
Type USA	033763	
pH electrode	11056842	③
or (according to purchase order)		
colorimetric sensor	11066601	④
Accessory kit for colorimetric sensor (if device version with colorimetric sensor is shipped)	11068260	
Indicator according to Sher, 100 mL (if device version with colorimetric sensor is shipped)	003512	⑤
Buffer set pH 4 and pH 7, 3 x 20 mL each (if device version with potentiometric sensor is shipped)	043188	
KCl electrolyte, sat. , 250 mL (if device version with potentiometric sensor is shipped)	11059759	⑥
Connection grommet for Chiller	049151	⑦
Hose connector in line 11–13 for waste tank	043178	
Hose chemical supply, Nylflex, length 6 m, Ø 5/10 mm	043185	
Suction tube to tanks, FEP, length 580 mm	043407	
Hose waste drain, EPDM, L = 1.8 m, ø 11/18 mm	043457	
Clamp D15.6	049167	
Clamp D12.8	043297	
Clamp D11.9	043841	
Silicone hose ø 8 mm/12x1.8m	11058157	
Y-piece ø12 mm	11058358	
Cooling water hose complete: G 3/4", G 1/2", L = 1.5 m	037780	
O-ring 190.1 x 3.53 EPDM 75	049676	⑧
O-ring 247.2 x 3.53 EPDM	11058241	

Description	Order number	Picture
FEP tube, 1.2 m, to driving motor	11056837	
Capacitive level sensor for chemical or waste tank	11055914	⑨
Laboratory vessel	053203	
Driving motor for dosing unit	11056835	⑩
Dosing unit (20 mL)	11056836	⑪
Test gauge sample tube holder	11059802	⑫
Tank 10 L	043410	⑬
Cap for 10 L tank, large	025869	⑭
Cap for 10 L and 20 L tank, small	043477	⑮
Tank labels	043434	
Tank 20 L	043408	⑯
Cap for 20 L tank, large	043478	⑰
Distance holder for dosing tip	043203	⑱
Mini gender changer	043108	
Weighing boats (20 pcs)	11060522	
EPDM sealing for tanks	043048	
Open end spanner	11058252	⑲
Tool SVL 22	11057779	⑳
CD Kjellink PC software (with 60 days test license)	11058664	

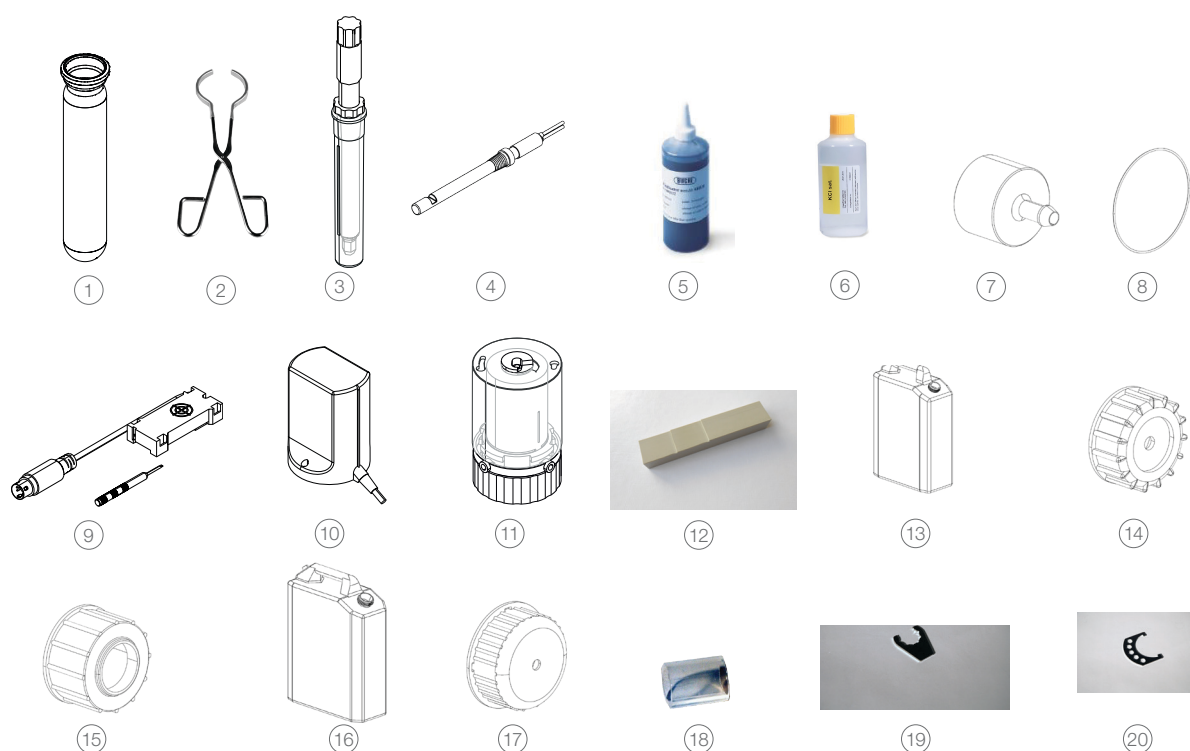

3.1.3 Standard accessories for K-376 / K-377

Description	Order number	Picture
K-376 / K-377 cable RS232 (crossed)	043920	①
Sample tube 500 mL	026128	②
Clamp ring	043238	③
Hose clamp	022352	④
Fastener for transfer tube (K-376 only)	043482	
Sample tubes (set of 4), 300 mL	037377	⑤
Express rack, 4 places (K-376 only)	11057711	⑥
Rack, 20 places	11059831	⑦
Mains cable of the following types:		
Type CH	10010	
Type Schuko/Japan	10016	
Type GB	17835	
Type AUS	17836	
Type USA	33763	
Test gauge for sample tubes	11058240	⑧



①

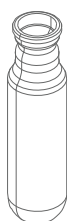

②

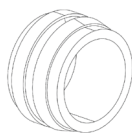

③

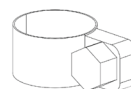

④



⑤



⑥

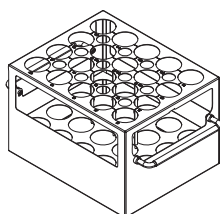

⑦



⑧

3.1.4 Operation Manuals for K-375

Description	Order number
English	11593514
German	11593515
French	11593516
Italian	11593517
Spanish	11593518
Chinese	11593519
Japanese	11593520
Russian	11593653
KjelMaster K-375 Network Connection	11593539
KjelMaster K-375 - Data Export	11593558

3.1.5 Optional accessories K-375

Description	Order number	Picture
Sample tubes (set of 4) 100 mL	11057442	①
Sample tubes (set of 4) 300 mL	037377	②
Sample tubes (set of 20) 300 mL	11059690	②
Sample tubes (set of 4) graduated 300 mL	043049	③
Sample tubes (set of 4), 500 mL	043982	④
Sample tube holder for 4 sample tubes 500 mL each	016951	
Receiving vessel 340 mL	043333	⑤
Receiving vessel 420 mL	043390	⑥
10 L chemicals	043468	⑦
10 L waste	043470	⑧
20 L chemicals	043469	⑨
20 L waste	043471	⑩
O-ring level sensor (10 L tank)	049676	⑪
O-ring level sensor (20 L tank)	11058241	⑫
Buffer solution pH 4, 250 mL	11064974	
Buffer solution pH 7, 250 mL	11064975	
Temperature sensor for titrator	11056851	⑬
2% boric acid with Sher indicator	11064972	
4% boric acid with Sher indicator	11064973	
4% boric acid with bromocresol green/methyl red indicator	11064976	
Dosing unit (for back titration)	11056836	⑭
Driving motor for dosing unit	11056835	⑮
IQ/OQ set K-375 (English)	11058677	
IQ/OQ set K-375 / K-376 / K-377 (English)	11058678	
Repeating OQ set K-375 (English)	11058679	
Repeating OQ set K-375 / K-376 / K-377 (English)	11058680	
Glass splash protector	043332	⑯
Plastic splash protector	043590	⑰
Devarda splash protector	043335	⑱
Adapter set for 3 rd party sample tubes	11058410	⑲
Receiving vessel, colorimetric titration	11068263	⑳

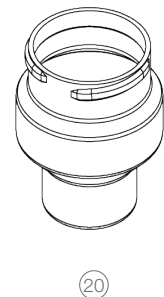
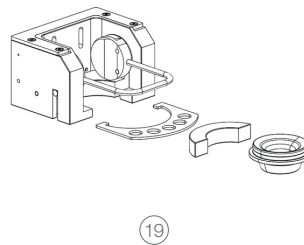
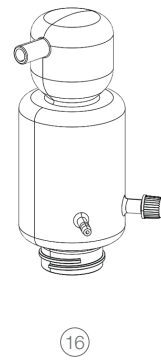
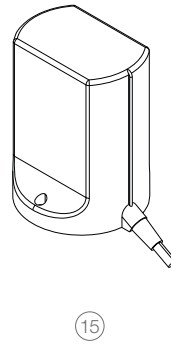
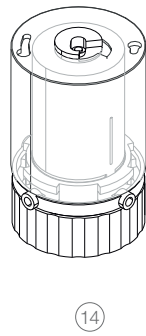
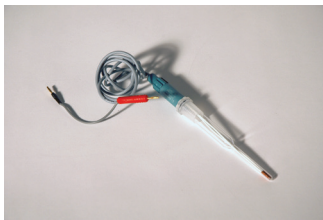
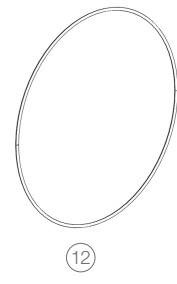
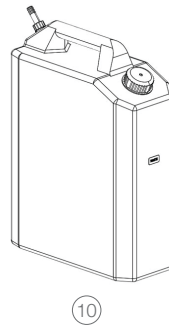
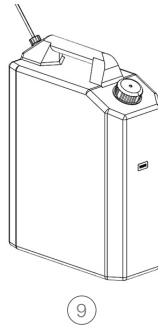
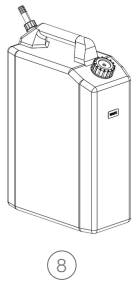
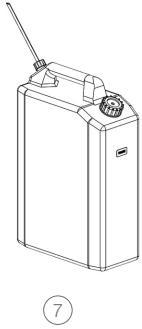
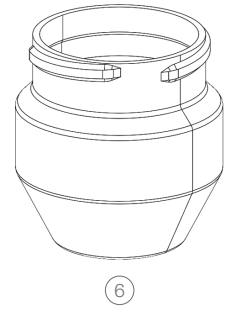
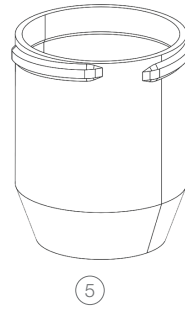
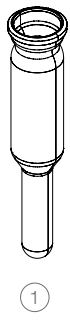

3.1.6 Optional accessories K-376 / K-377

Description	Order number	Picture
Stand for rack	11058659	①
Rack for 12 sample tubes, 500 mL	043970	②
Retainer plate (holds tubes firmly in rack for machine washing)	038559	③
Set of 10 boiling rods for digestion of samples with tendency of boiling retardation (alternative for boiling chips)	043087	④
Dip tube with cross-slot for soil/stone containing samples	047845	⑤
Glassfinger for sample tubes for soil samples	048638	⑥

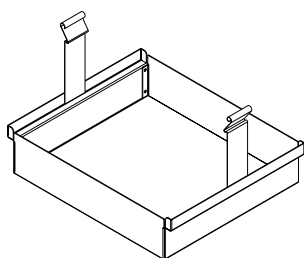

①

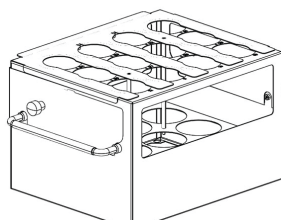

②

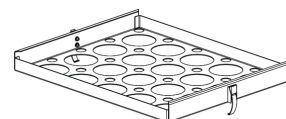

③

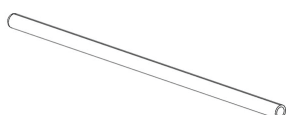

④

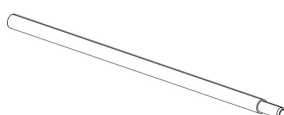

⑤



⑥

3.2 Technical data overview

3.2.1 Technical data KjelMaster K-375 and KjelSampler K-376 / K-377

	KjelMaster K-375	KjelSampler K-376	KjelSampler K-377
Connection voltage	220 – 240 VAC ±10 %	100 – 240 VAC ±10 %	100 – 240 VAC ±10 %
Frequency	50/60 Hz	50/60 Hz	50/60 Hz
Power consumption	max. 2.2 kW	max. 150 W	max. 150 W
Current consumption (230 V)	9.5 A	650 mA	650 mA
Weight	32 kg	40 kg (without rack and sample tubes)	64 kg (without rack and sample tubes)
Dimensions (W x H x D)	458 x 670 x 431 mm	505 x 750* x 655 * 1000 mm height required to allow free movement of the sampler arm	1015 x 750** x 655 **1250 mm height required to allow free movement of the sampler arm
Interfaces	RS232	RS232	RS232

Recovery rate	> 99.5 % (1 – 200 mg N)		
Reproducibility (RSD)	< 1 %		
Measuring range	0.02 – 200 mg N		
Environmental conditions	for indoor use only		
Temperature	+ 5 °C to + 40 °C		
Altitude	up to 2000 m above sea level		
Humidity	maximum relative humidity 80 % for temperatures up to 31 °C, decreasing linearly to 50 % relative humidity at 40 °C		
Mains connection	Device plug C14	Device plug C14	Device plug C14
Overvoltage category	II	II	II
Pollution degree	2	2	2
Approval	CE/CSA	CE/CSA	CE/CSA

3.2.2 Technical data titrator

The following sensors can be connected to the titrator:

- combined pH glass electrode
- optical sensor
- temperature measuring sensor for Resistance Thermometer Pt 1000, connection: 2 x 4 mm sockets and 1 x 2 mm socket

Dosing accuracy:

According to DIN EN ISO 8655, Part 3, or better

Typical accuracy: Fulfills ISO/DIN 8655-3 regulation

Measuring input: pH/mV input with 12 bit transducer for accurate resolution during the titration

Connection:

electrode socket according to DIN 19 262 or BNC socket and reference electrode 1 x 4 mm socket

Measuring range	Display resolution	Accuracy* without sensor	Input resistance (Ω)
pH 0...14	0.01	0.05 \pm 1 digit	$> 5 \cdot 10^{12}$
mV -1400 ... +1400	0.1	2 \pm 1 digit	$> 5 \cdot 10^{12}$
sensor	Measuring range	Display resolution	Accuracy* without

T [°C]	-30...115	0,1	0,5 K ±1 digit
--------	-----------	-----	----------------

***Accuracy:**

Indicated in terms of measuring uncertainty with a confidence of 95 %. In addition the measuring uncertainty of the sensor has to be taken into account as well. For pH electrodes e.g.: $\Delta \text{pH} = 0.012 \dots 0.03$ according to DIN 19266, Part 3.

3.3 Determination parameters

The amount of sample and the concentration of the titrant should be optimized, so that the titrant volume is between 3 and 17 mL (buret volume: 20 mL).

Nitrogen content absolute	Nitrogen content relative	Protein content relative (Protein factor 6.25)	Sample size	Boric acid concentration	Titration concentration	Titration volume
0.02 mg	20 ppm		1.0 g	2 % (+3 g KCl/L)	0.005 N	2 mL
0.1 mg	100 ppm		1.0 g	2 %	0.005 N	3 mL
1 mg	0.2 %	1 %	0.2 g	2 %	0.01 N	8 mL
5 mg	1 %	6 %	0.5 g	2 %	0.1 N	4 mL
10 mg	1 %	6 %	1.0 g	4 %	0.1 N	8 mL
20 mg	2 %	13 %	1.0 g	4 %	0.1 N	14 mL
50 mg	5 %	31 %	0.4 g	4 %	0.1 N	14 mL
100 mg	10 %	63 %	1.0 g	4 %	0.5 N	14 mL
100 mg	20 %		0.5 g	4 %	0.5 N	14 mL
200 mg	20 %		1.0 g	4 %	0.5 N	28 mL

General recommendation

The correction factor for self prepared solutions is called titer.

The use of standardized titration solutions make a titer determination unnecessary.

Exact titration concentration = concentration x titer

The titer of the titration must be known. In case, it is unknown, it must be determined.

Example: Exact titration concentration = $0.100 \text{ mol/L} \times 0.998$

3.4 Information on type plate

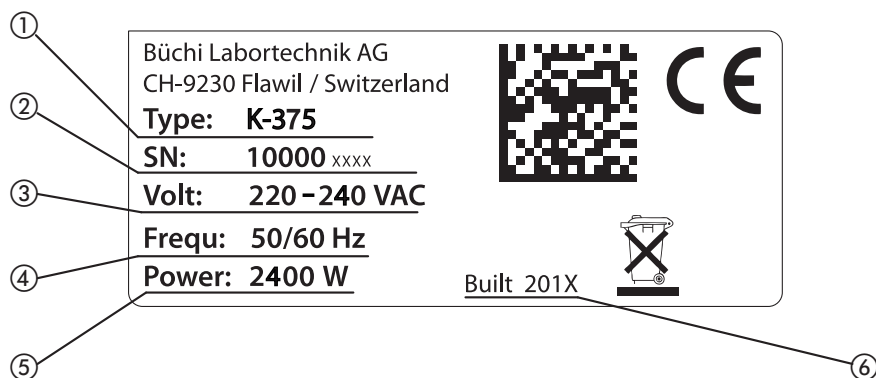

① Device type code

② Serial number

③ Supply voltage range/type

④ Frequency of supply voltage

⑤ Nominal power rating

⑥ Year of manufacture

Materials used

3.4.1 Titrator module and dosing unit

part	Material designation
Housing	sheet steel

Note

For the materials of the Dosing Unit, please refer to its manual which is delivered together with dosing unit.

3.4.2 Material on the K-375

Part	Material	Material code
Housing	Polyurethane	PUR/UL VO
Glass parts	Borosilicate glass 3.3	DIN/ISO 3585
Insulation steam generator	Ceramic fiber	Multitherm 550
Steam generator housing	Stainless steel	1.4301
Protective door	Polymethyl methacrylate	PMMA
Seal ring	Chlorosulfonyl polyethylene elastomer	CSM

3.4.3 Material on the K-376 / K-377

Part	Material	Material code
Housing (mounting plate)	Steel sheet St 12 ZE	1.0330
Housing (casing-below)	Stainless steel	1.4301 (L 314)
Housing (top cover)	Alu-sheet	AlMgSi1
Guide express rack	PP	PP
Coating	Polyester/Epoxy	PEP 31
Protective shield	Polymethyl methacrylate/Alu	PMMA/Alu
Drip tray	Polypropylene	PP
Housing y-axle	Alu-sheet	AlMgSi1
End cap y-axle	POM	POM
Dip tube	PVDF	PVDF
Sealing cap	EPDM	EPDM
Transfer hose linear	PTFE	PTFE
Steam tube	Silicone/polyester	MQ-PU
Protective hose	PP	PP
Hose chain	PA	PA

4 Description of function

This chapter explains the basic principle of the instrument, shows how it is structured and gives a functional description of the assemblies.

The KjelMaster K-375 is dedicated to Kjeldahl and Devarda nitrogen determination including potentiometric or colorimetric titration.

Automation of Kjeldahl determination is possible with the KjelSampler K-376 / K-377.

4.1 Device overview



- | | |
|--------------------------------|----------------------------------|
| ① KjelMaster K-375 | ⑨ Sample tube |
| ② KjelSampler K-376 | ⑩ Protective door |
| ③ Protective shield | ⑪ Condenser |
| ④ Rack with sample tubes | ⑫ Receiving vessel |
| ⑤ Handle for protective shield | ⑬ Touch screen with display |
| ⑥ Transfer hose | ⑭ pH electrode or optical sensor |
| ⑦ Splash protector | ⑮ Service door |
| ⑧ Sample tube bracket | ⑯ External buret |

Fig. 4.1: Device overview

NOTE

The main switch of each device can be found on the rear right side of the housing.

4.1.1 Opening the service door

The service door is secured with a sensor/switch: Electrical power is disconnected immediately when the service door is opened, thus preventing electrical shock during maintenance.

To open the the service door for maintenance proceed as follows:

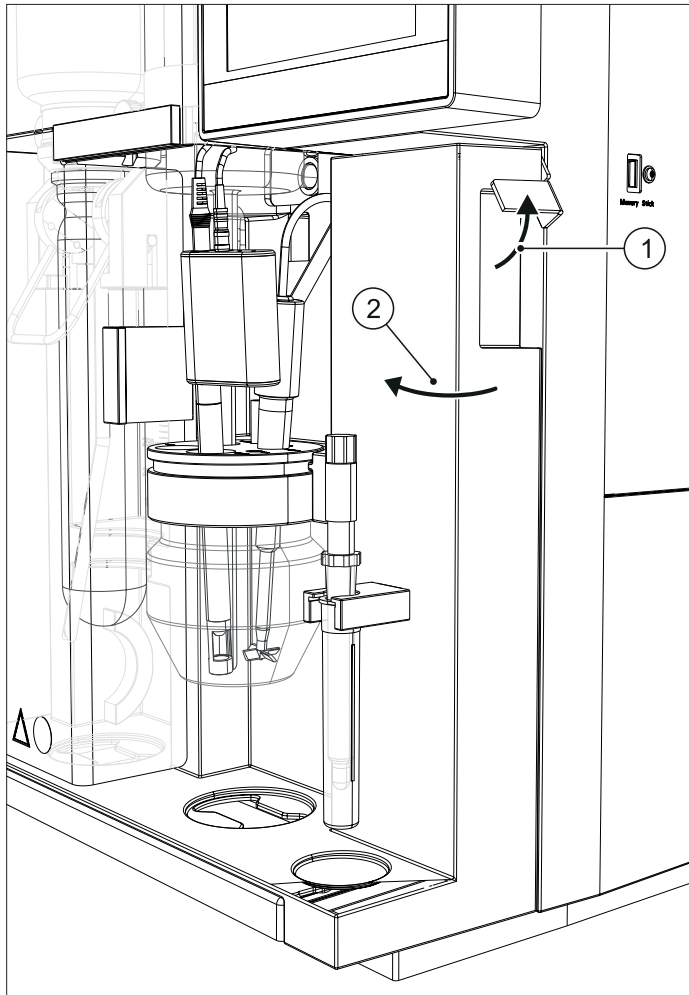

To open the service door,

- pull the door lock ① upwards
- open the door ②

Fig. 4.2: Opening the service door

4.2 Functional principle of KjelMaster System K-375 / K-376 / K-377

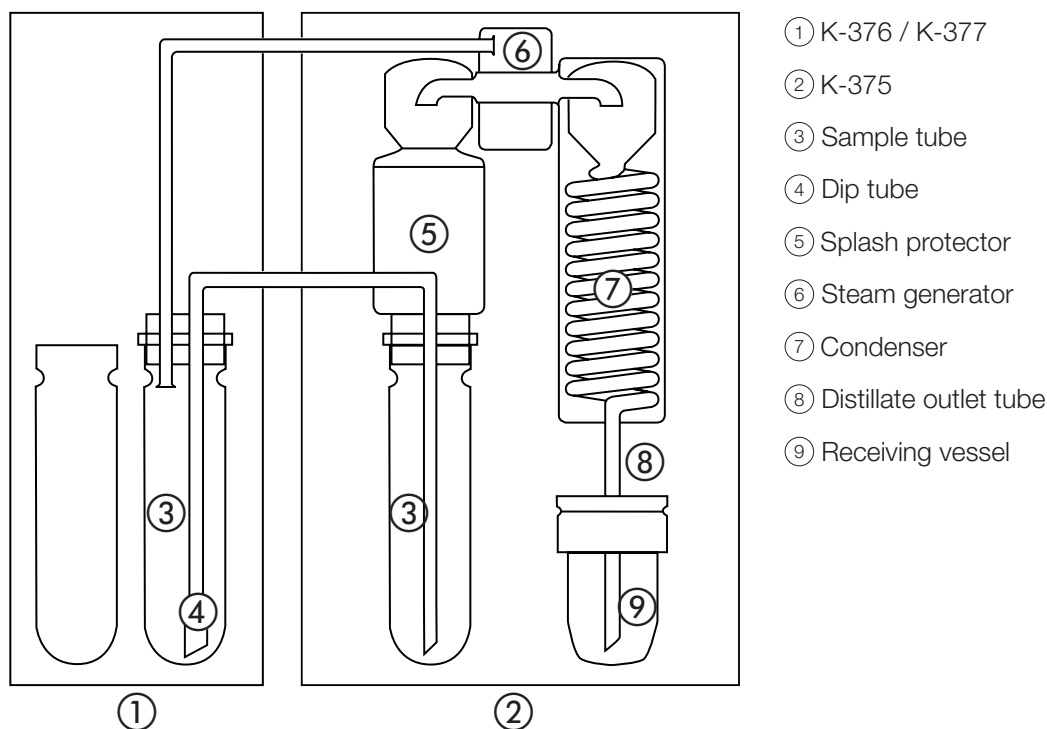

Fig. 4.3: Functional principle of the K-375 with K-376 or K-377

The sampler arm with dip tube is positioned in a sample tube in the K-376 / K-377. The steam generator of the K-375 generates steam which is led into the sample tube in the K-376 / K-377 via the steam hose.

The steam presses the sample into the dip tube, so that the sample is transferred into the sample tube in the K-375 via the transfer hose.

Water and sodium hydroxide is dosed into the sample tube in the K-375. Then steam is introduced to drive out ammonia. The ammonia evaporates into the splash protector and condensates in the condenser.

Boric acid is dosed into the receiving vessel, where the condensed ammonia is collected and finally titrated.

During the entire distillation process, steam is transferred via the sample tube of the K-376 / K-377 to the sample tube of the K-375, thus ensuring a thorough cleaning of the sample tube and the transfer hose.

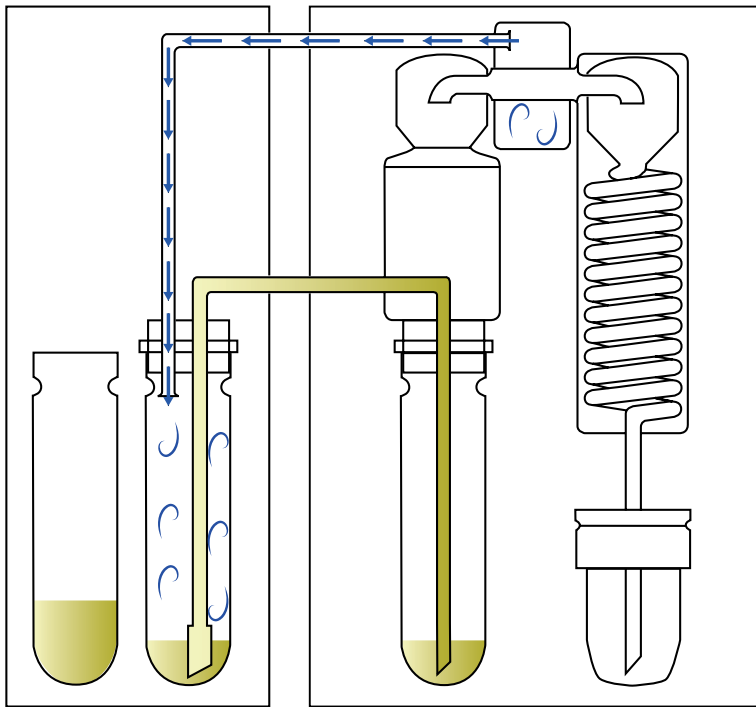

Fig. 4.4: Sample transfer principle

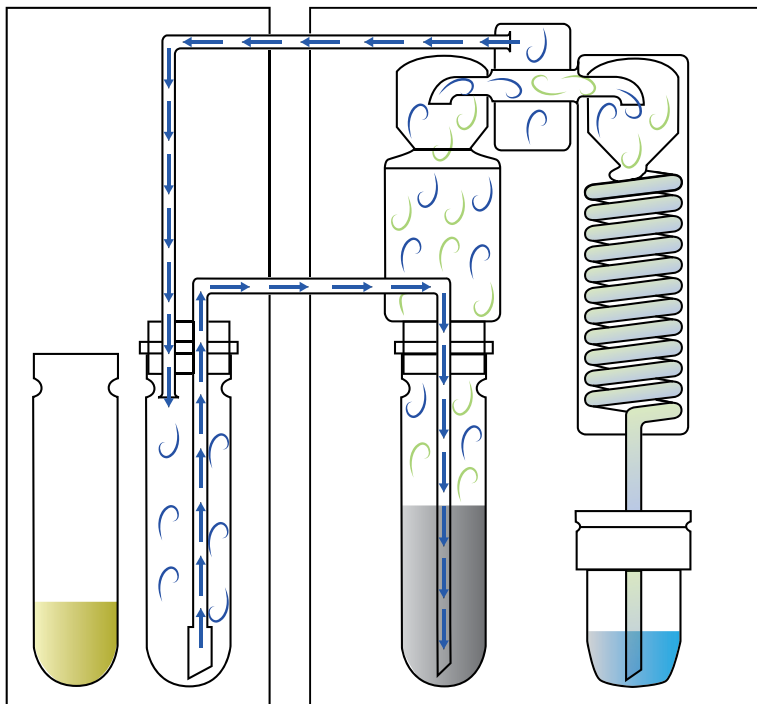

Fig. 4.5: Steam transfer during distillation

4.3 Standby function

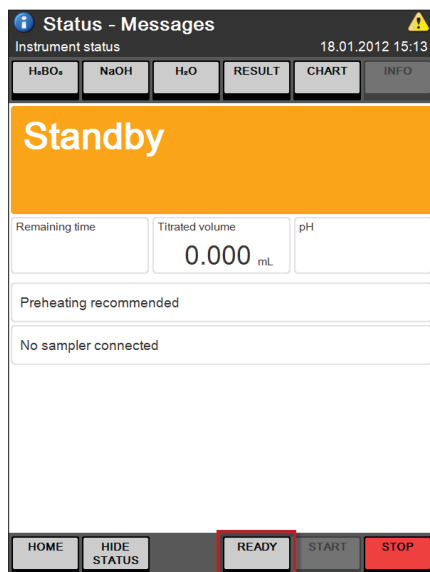

Fig. 4.6: Status view

Press the key **READY** to start heating the steam generator.

Press the key **STANDBY** to stop heating the steam generator.

After 30 minutes without operation, the heating of the steam generator is automatically turned off. In this case „Standby“ is displayed on the Status view.

To activate the device press the **READY** key. The steam generator will need 120 seconds for heating up to the operating temperature.

4.4 System preparation

4.4.1 Preheating

The glass parts of the distillation system have to be preheated prior to analysis. This is done by means of a clean and empty sample tube. It is recommended to perform a preheating, when the glass (splash protector) has cooled down. The preheating time is predefined and can not be adapted.

4.4.2 Priming

Priming is used to prepare the entire system. This preparation procedure includes distillation and titration with a clean and empty sample tube. It is recommended to perform a priming at least once a day, before starting analysis. The priming method can be modified.

4.4.3 Cleaning

At the end of a day, the system should be rinsed thoroughly by performing a cleaning procedure. The splash protector and the condenser are rinsed with water to remove sodium hydroxide residues. With regular cleaning, the lifetime of the glass parts is extended. The cleaning method is predefined, but should be modified and adapted to the size of the sample tube.

4.4.4 Aspiration

With this procedure residues in the sample tube and in the receiving vessel can be aspirated.

For more details see also chapter “6.6.1 System preparation”.

4.5 Distillation and titration

4.5.1 Distillation and Titration Options

	Titration type		Titration mode		Distillation mode		Measuring mode			Titration algorithm	
	Boric acid	Back titration	Standard	Online	IntelliDist	Fixed time	Endpoint pH	Startpoint pH	Setpoint mV	Optimal	Normal
Potentiometric	x	x	x	x	x	x	x	x		x	x
Colorimetric	x		x	x		x			x	x	x

4.5.2 Distillation Mode

Automatic – IntelliDist

This mode eliminates errors caused by a cooled instrument. The countdown of the set distillation time only starts after operating temperature is attained. With single samples or sample list measurements this mode guarantees result accuracy from the very first run.

Fixed Time

The countdown of the set distillation time starts immediately with the start of the distillation process. This setting is recommended when a sample changer is used for the analysis of samples in a rack (or sequence).

4.5.3 Titration Type

The built-in titrator is fully controlled via the K-375 software. It is not possible to use the titrator without the KjelMaster K-375. It can be used for boric acid or back titration. The measuring mode can be determined as endpoint or startpoint titration by defining the method in the K-375. The software of the K-375 allows to choose between standard and online titration.

Boric Acid Titration

Boric acid adjusted to a pH of 4.65 is used as receiving solution to capture the nitrogen carried over as ammonia during the steam distillation. The subsequent endpoint titration (pH 4.65) is performed with an acid titration solution. This titration type does not require an accurate dosage of the boric acid.

Back Titration

The receiving solution is a standardized acid (e.g. H_2SO_4) of which an accurate volume is dispensed into the receiving vessel. After collecting the ammonia the excess acid is titrated with a basic titration solution (NaOH) at pH 7.00. If the use of boric acid has to be avoided the back titration is the procedure of choice.

4.5.4 Sensor Type

Potentiometric

Potentiometric pH measurement is commonly used and allows both boric acid and back titrations. They need regular calibration with buffers.

Colorimetric

Colorimetric titration is based on colour change at the equivalence point and is used in situations where an official standard requires it. For sound measurements and reproducible results the condensate outlet with air bubble trap must be fitted. The condensate outlet prevents air bubbles interfering

with the measurement. Colorimetric titration requires daily determination of the setpoint.

4.5.5 Titration Mode

Standard

In the standard mode the distillation and titration are performed sequentially. First the distillation is completed then the titration starts.

Online

In the online mode the titration starts while the distillation is still in progress. The start time of the titration depends on the pH value and is determined automatically. It helps optimize the speed of measurements as it saves time.

4.5.6 Measuring Mode

Startpoint pH

The device measures the pH of the boric acid before the distillation is started and uses it later on as endpoint for the titration. When startpoint titration is used, the pH must not be adjusted to 4.65, but it must be between 4.4 and 5.0.

Endpoint pH

The set value, normally 4.65, is used as endpoint for the titration. The boric acid has to be adjusted to pH 4.65 before starting sample measurements. This mode is more accurate and yields the highest accuracy.

Setpoint mV (colorimetric)

The setpoint must be determined daily before the blank values and samples are colorimetrically tested, and in addition, if the distillation time, the boric acid, the indicator or the titrant is changed. The setpoint determined is then used as the end point for the subsequent colorimetric titrations.

4.5.7 Titration Algorithm

Normal

This algorithm is the most accurate one and is recommended for samples with low nitrogen content (below 1 mg) and for the use of highly-concentrated titration solutions (e.g. 0.5 N acids).

Optimal

The best ratio between accuracy and process speed is achieved with this algorithm.

4.5.8 Determination Mode

Standard

In the majority of cases it is necessary to digest samples to make the nitrogen accessible to steam distillation. Whenever digested samples are analyzed the standard determination mode is used.

Direct Distillation

A small number of applications allow freeing the nitrogen via direct steam distillation without requiring a digestion. In such a case the direct distillation mode needs to be activated.

4.6 Different methods

BUCHI standard methods are stored in the instrument. All BUCHI methods are “read only“, but it is possible to copy and save them under a different name as an editable customer method.

All methods are listed in alphabetical order, customer methods are first, followed by the “read only” BUCHI methods (marked with a small yellow lock).

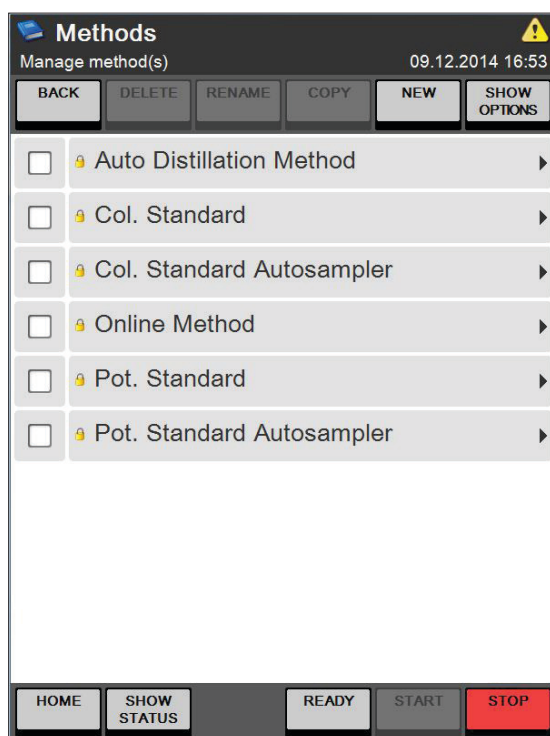

Fig. 4.7: Methods screen

4.7 Blank values

The K-375 differentiates between blanks and control blanks. Blanks are performed to correct minimal contamination of chemicals on sample determination (sample and reference substance).

Control blanks are performed to check the determination process for cross contaminations and are not used for calculation.

The determination and the definition of blank values is described in chapter 6 Operation.

4.7.1 Blanks

It is recommended to run blank values with exactly the same method as the subsequent samples. The blank values may vary, depending on the receiver solution (e.g. concentration of the boric acid, amount of indicator added, pH value set), the concentration of the titration solution, and the purity of chemicals.

It is recommended to perform blank values, if:

- Fresh chemicals are used or
- Before starting determination in order to check the system.

If a blank value is activated for calculation, it remains active, until another blank value is activated.

4.7.2 Control blanks

A control blank enables to check for cross contamination, e.g. in the middle of a rack, without affecting the calculation of the following samples.

Example:

Determination of

3 blanks, 6 samples, 1 control blank, 10 samples in a 20-position rack.

All samples are calculated with the mean value of blank 1-3. The control blank allows to check the system without interruption.

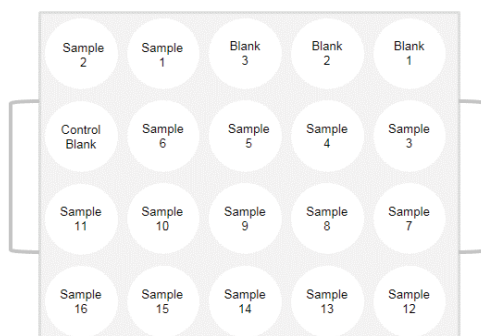

Fig. 4.8: Example of rack containing a control blank

4.8 Reference substances

Reference substances are substances with known nitrogen content and serve to check the performance of the system and the application.

It is recommended to analyze reference substances regularly. For information on reference substances, see table.

A check of the K-375 without digestion is done with a standardized ammonium salt (e.g. ammonium di-hydrogen phosphate).

In order to check the entire Kjeldahl process (including digestion), standardized amino acids are used (e.g. Glycine).

The determination of reference substances is done like a normal sample determination (Sample type: "Reference substance") as single sample, sample list or a sequence. See Chapter "6.6 Determination" for details.

Name	Purity	Reference Substances				
		*Commer- cially available purity	% N theo- retical (100 % purity)	Recom- mended sample size	Recommended titrant concen- tration	Digestion necessary
Ammonium dihydrogen phosphate	100	99.5	12.18	0.2 g	0.2 N	No
Glycine	100	99.7	18.66	0.2 g	0.2 N	Yes
Phenylala- nine	100	99.0	8.47	0.3 g	0.2 N	Yes
Ammonium sulfate	100	99.5	21.21	0.1 g	0.2 N	No
Tryptophan	100	99.0	13.72	0.2 g	0.2 N	Yes
Acetanilide	100	99.0	10.36	0.2 g	0.2 N	Yes

* this is only a guideline; please verify and use your specific purity of the reference substance. Therefore, check the respective "Certificate of Analysis" which is delivered from the manufacturer of the reference substance and create a modified reference substance according to it.

4.9 Indicator for colorimetric titration

To detect the endpoint during a colorimetric titration an indicator must be added to the boric acid. For optimal performance the Sher mixed indicator is recommended.

The point of inflection is depending on the indicator type as well as on the added indicator amount.

The Sher indicator shows best performance in terms of endpoint detection speed and reliability.

In boric acid the color changes from green (pH >7.6) to blue (7.4 to 4.8) and finally to the gray endpoint (pH 4.6).

The optimal ratio of the Sher indicator to boric acid is 2.5 mL per 1 L boric acid.

NOTE:

Even the slightest changes to the ratio can result in incorrect end point determination. As an alternative, methyl red/bromocresol green mix indicator can also be used. Ready-made, premixed boric acid solutions for both indicator options can be obtained from Buchi.

4.10 Result Groups

Each result of a sample determination can be assigned to a group, e.g. the results of samples taken from the same batch/lot, place, at the same day, etc. can be assigned to the same result group.

All results in the same group are treated the same way regarding sample printout and export of data.

4.11 Explanation of alkaline direct distillation

As an example, the protein content in milk samples can be determined by direct distillation. This quick method is based on the fact that milk releases ammonia when boiled in an alkaline solution. Most of this ammonia is produced by the rapid hydrolysis of proteins containing glutamine and asparagine. This decomposition is completed within a few minutes. An additional quantity of ammonia, although small, is released through the complete transformation of other amino-acids. This second reaction occurs very slowly however, and does not interfere with the quick method. This fact permits an experimental determination of the ratio of total nitrogen or protein to ammonia nitrogen which is released by boiling in an alkaline solution. Once the resulting conversion factor is determined, a series of analysis can be carried out for control purposes without the time-consuming digestion step. The overall analysis is reduced to the following steps:

- Sample addition
- Dilution
- Alkalisation
- Distillation
- Titration
- Calculation

A determination can be completed in approx. 10 minutes according to this procedure. All working conditions chosen for the experimental determination of the conversion factor must be strictly adhered to during sample measurements.

For details on the application procedure, please contact your local BUCHI representative.

Determination of the conversion factor and the regression factor:

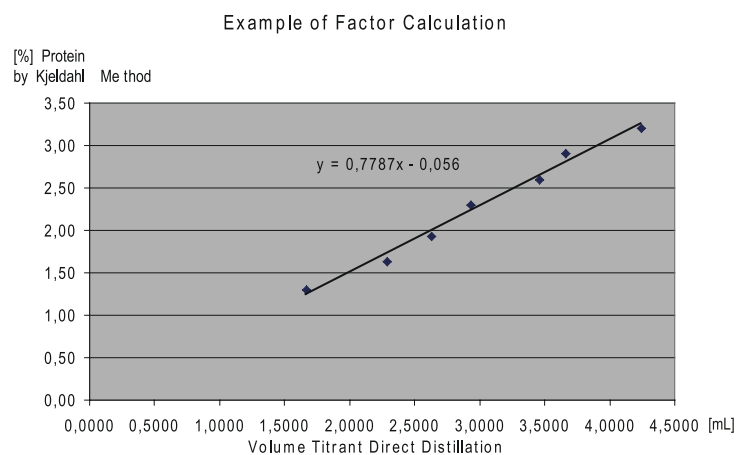

Fig. 4.8: Example of factor calculation

Factors of above Example

Conversion Factor = 0.7787; Regression Factor = -0.055.

NOTE

Milk samples with a reduced protein content are obtained by dilution with distilled water.

Calculation:

Calculation of the protein content after factor determination.

$$\text{g protein/100 mL} = (V_{\text{sample}} - V_{\text{blank}}) \times \text{Conv. Fact.} + \text{Reg. Fact.}$$

V_{sample} = Volume Titrant for sample determination in mL

V_{blank} = Volume Titrant for blank determination in mL

Conv. Fact. = Conversion factor for direct distillation

Reg. Fact. = Regression factor for direct distillation

5 Putting into operation

This chapter describes how the device is installed and gives instructions on initial startup.

NOTE

Inspect the device for damages during unpacking. If necessary, prepare a status report immediately to inform the postal company, railway company or transportation company.

Keep the original packaging for future transportation.

	CAUTION
	<p>Heavy weight, avoid overexertion.</p> <ul style="list-style-type: none"> · Due to the heavy weight of the devices at least two people are required for taking the KjellMaster K-375 or the KjellSamplers K-376 out of their corresponding packaging. Watch your fingers when putting the device down. · For the K-377 at least three people are required for taking the device out of the corresponding packaging. Watch your fingers when putting the device down.

5.1 Installation site

The device must be set-up on a stable, clean and level surface.

For safety reasons the distance between the back of the device and the wall or to another object must be at least 30 cm. No containers, chemicals or other objects must be located behind the instrument.

The KjellSampler K-376 or K-377 is set-up **on the left side** of the KjellMaster K-375 with a space of approximate 10 cm. Make sure that the back of the KjellSampler is not in contact with anything, e.g. hoses, etc.

All devices must be set up in such a way that the main switches and the mains plugs are easily accessible at all times.

	NOTICE
	<p>Risk of device damage.</p> <ul style="list-style-type: none"> · The sampler arm of the KjellSampler K-376 / K-377 must have enough space in height for movement.

	CAUTION
	<p>Heavy weight, avoid overexertion.</p> <ul style="list-style-type: none"> · At least two people are required for carrying the KjellSampler K-376 or the KjellMaster K-375 due to the heavy weight of the devices. Watch your fingers when putting the devices down. · At least three people are required for carrying the KjellSampler K-377 due to the heavy weight of the device. Watch your fingers when putting the device down.

5.2 Electrical connections

5.2.1 Connections of the KjellMaster K-375

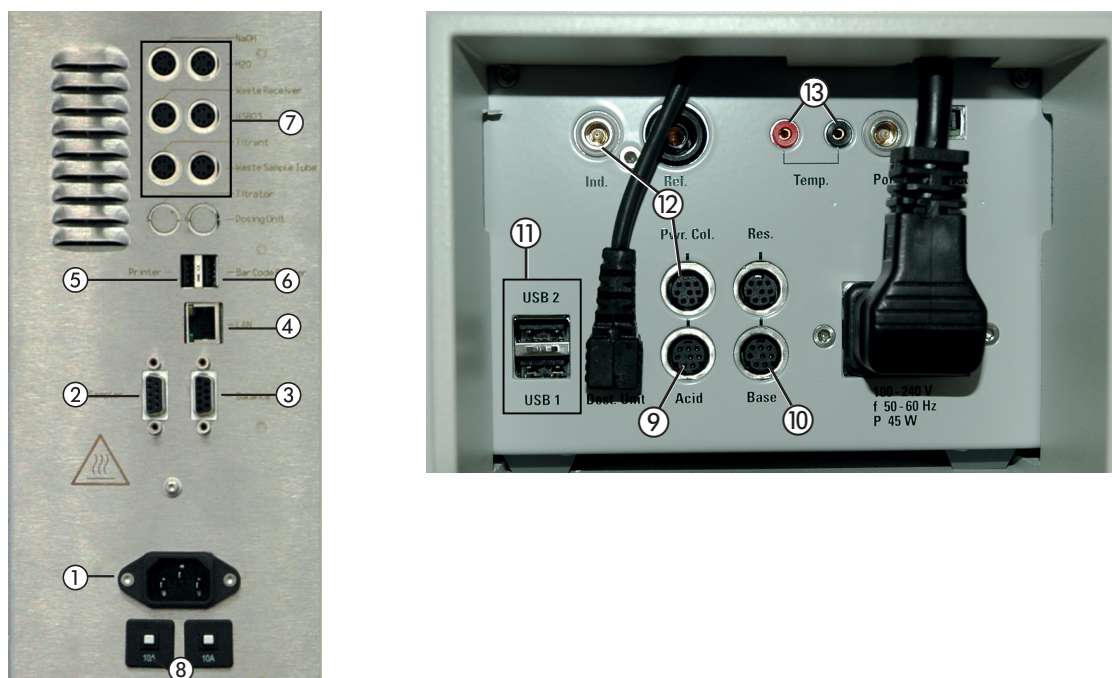

- | | |
|--------------------------------------|---|
| ① Power connection K-375 | ⑧ Fuses (2 x 10A) |
| ② RS232 connection to K-376 / K-377 | ⑨ Connector for dosing unit (Acid) |
| ③ RS232 connection to balance | ⑩ Connector for additional dosing unit (Base) |
| ④ LAN connection | ⑪ Additional USB-ports |
| ⑤ USB connection to printer | ⑫ Connectors for colorimetric sensor (Ind. and Pwr. Col.) or pH electrode (Ind. only) |
| ⑥ USB connection for bar code reader | ⑬ Connectors for temperature sensor |
| ⑦ Connectors for level sensors | |

Fig. 5.1: Electrical connections of the K-375

	NOTICE
<p>Risk of device damage by wrong voltage.</p> <ul style="list-style-type: none"> · Make sure that the voltage on the socket corresponds to the voltage given on the type plate of the instrument. · Always connect the device to an earthed socket. External connections and extension cables must be provided with an earthed conductor lead (3-pole couplings, cable or plug equipment) as the mains lead has a molded plug, thus avoiding risks due to inadvertent defective wiring. · Make sure that no electric sparks form in the device or its surroundings as they might damage the instrument. 	

On the KjellMaster K-375

- Connect the power cable to the power connection ①.
- Connect the level sensors to the corresponding connectors ⑦.

NOTE

Unlike the level sensors for the storage tanks of H_2O , $NaOH$ and H_3BO_3 , the presence of the level sensors for the waste containers has to be indicated within the software! (See section "Peripherals" in chapter 6.9.1)

- Connect the dosing unit for the acid to connector ⑨.
- Connect the RS232 cable to the sampler (if present) to the corresponding connector ②.
- Connect any additional peripherals according to the description in figure 5.1.

5.2.2 Connections of the K-376 / K-377

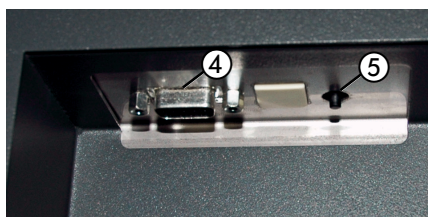

(left rear side of the housing)



(right rear side of the housing)

- ① Power switch K-376 / K-377
- ② Power connection K-376 / K-377
- ③ Fuses (2 x 3A)
- ④ RS232 connection to K-375
- ⑤ Toggle switch (see chapter 8.3)

Fig. 5.2: Electrical connections of the K-376 / K-377

	NOTICE
	<p>Risk of device damage by wrong voltage.</p> <ul style="list-style-type: none"> · Make sure that the voltage on the socket corresponds to the voltage given on the type plate of the instrument. · Always connect the device to an earthed socket. External connections and extension cables must be provided with an earthed conductor lead (3-pole couplings, cable or plug equipment) as the mains lead has a molded plug, thus avoiding risks due to inadvertent defective wiring. · Make sure that no electric sparks form in the device or its surroundings as they might damage the instrument.

On the KjelSampler K-376 / K-377

- Connect the power cable to the power connection ②
- Connect the cable to the K-375 device to the RS232 connector ④

5.3 Transfer connection K-376 / K-377 to K-375

The transfer connection between the K-375 and the K-376 or K-377 sampler consists of two hoses, the white transfer hose and the red steam hose.

Both hoses have to be connected to the K-375 as well as to the sampler (K-376 or K-377) and secured with hose clamps. The K-376 is delivered with both hoses premounted to the device.

	<p>! WARNING</p>
	<p>Serious chemical burns by corrosives. Risk of burns by hot steam.</p> <ul style="list-style-type: none"> · Never operate the K-375 together with a sampler while the sample transfer and steam hoses are missing, defective, or incorrectly mounted. · Make sure there is always enough room for a free movement of the sampler arm – if the sampler arm collides with any object during movement, the transfer hose and/or the steam hose may break!

5.3.1 Connecting the K-376 to the K-375

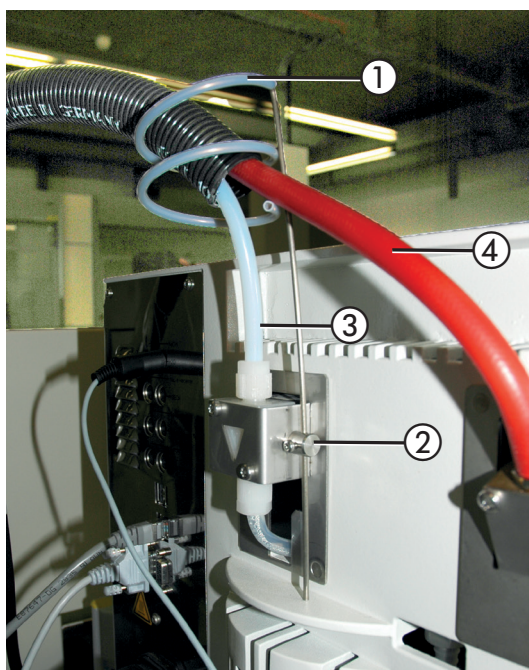

- Fix the transfer hose support ① with the screw on the valve ② on the rear side of the K-375.
- Guide both hoses ③ and ④ through the transfer hose support.

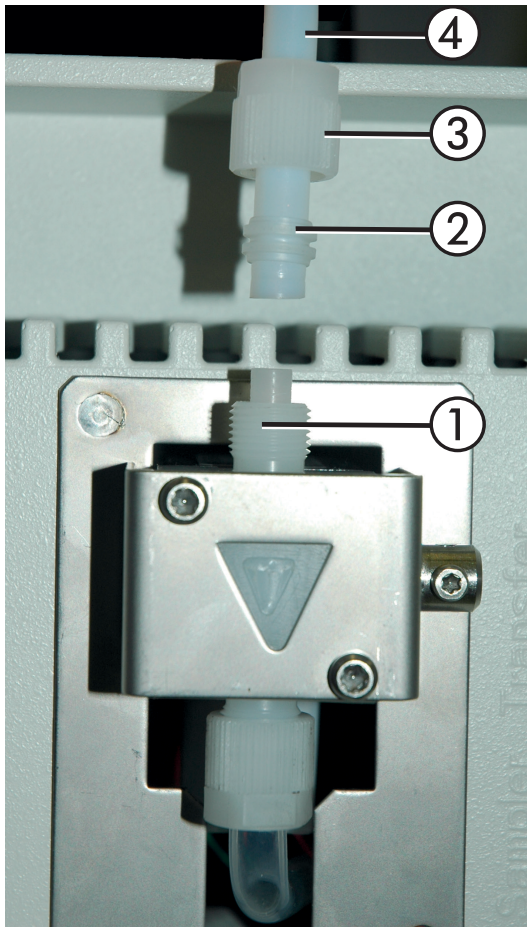

Fixing the transfer hose to the K-375

Mount the white transfer hose on the valve of the K-375 (top right corner):

- Unscrew the screw cap ③ from the screw connection of the valve ① (attention: 2 parts) and take out the cutting ring ②.
- Slide the screw cap over the white hose ④.
- Slide the cutting ring over the hose.
- Plug the hose on the valve and fix it by screwing the screw cap on the valve.

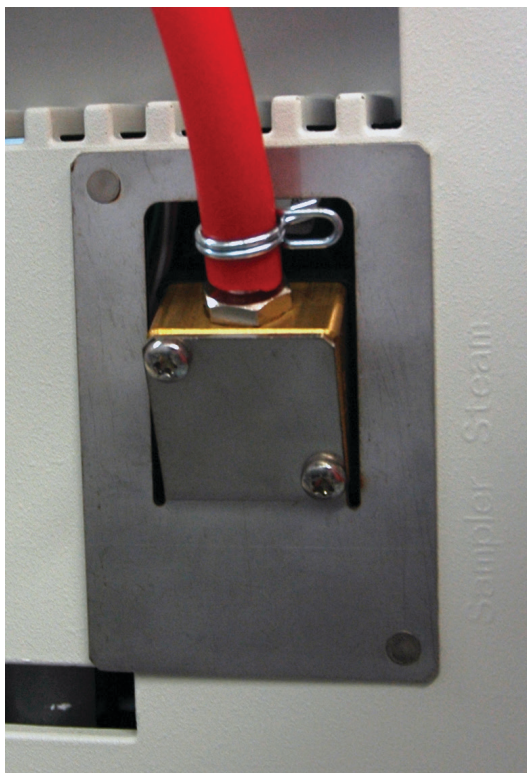

Fixing the steam hose to the K-375

Mount the red steam hose on the steam valve of the K-375 (top right corner):

- Slide the red hose on the connector and secure it with a hose clamp.

Fig. 5.4: Connection to the K-375

Connect the K-375 and the K-376 / K-377 with the corresponding/delivered RS232 cable (crossed)

- K-375: See ② in picture 5.1
- K-376 / K-377: see ④ in picture 5.2

	! WARNING
	<p>Risk of burns by hot steam.</p> <ul style="list-style-type: none"> · Make sure to place a sample tube in the washing position(s) of the sampler.

Place an empty sample tube into the washing position of the sampler:

The washing position is on the rear right side of the tray.

For the K-376 this is the fixed position to the right of the express rack.

The K-377 provides two washing positions – one on the rear right side of each tray.

5.3.2 Connecting the transfer hoses of the K-377

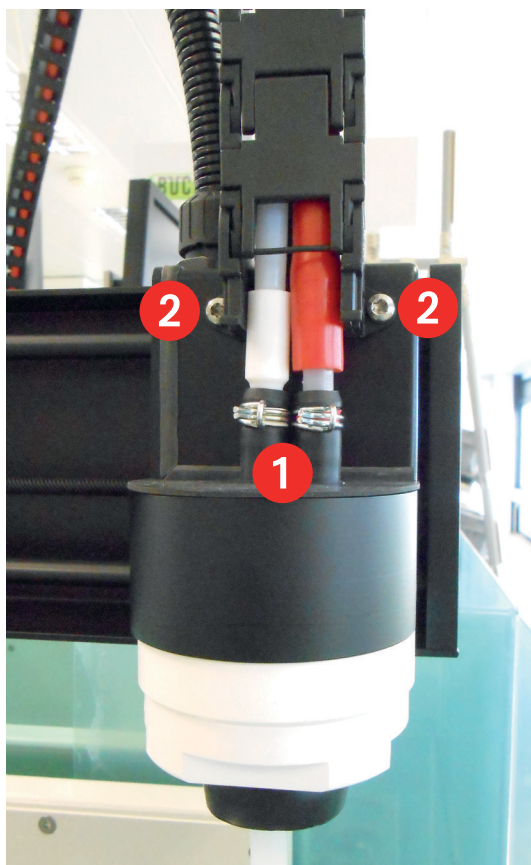

K-377

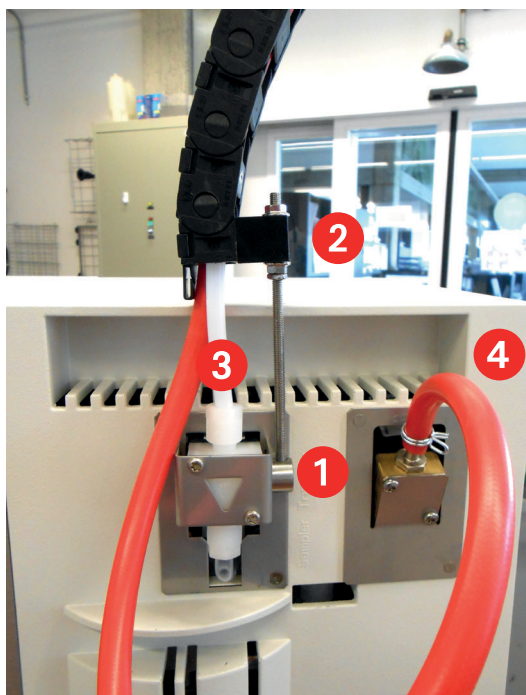

- Connect the transfer hose and the steam hose to the two fittings on top of the sealing cap on the sampler arm. Secure both connections with hose clamps ①.
- The red steam hose has to be fixed to the first position (marked with a red ring) – pointing to the front of the instrument!
- Fix the plastic cable channel with the two provided screws ② on the sampler arm.



On the K-375

- Remove the tightening screw from the holder on the valve **1**.
(The screw is not required for connection to K-377)
- Slide the ring of the chain fastener onto the holder on the valve **1** and fix it by tightening the threaded bar.
- Slide the the plastic holder of the transfer connection onto the threaded bar **2**. Hold it in place by screwing the second nut hand-tight on top.
- Mount the white transfer hose on the valve using the provided screw connection **3**.
- Mount the red steam hose on the steam valve and secure it with a hose clamp **4**.

5.4 Reagent/water and waste connections

	<p style="text-align: center;">NOTICE</p> <p>Risk of device damage by exceeding the maximum permissible pressure for the cooling water inlet.</p> <ul style="list-style-type: none"> · Make sure never to exceed the maximum permissible pressure of 6 bar for the cooling water inlet.
	<p style="text-align: center;">WARNING</p> <p>Serious chemical burns by corrosives.</p> <ul style="list-style-type: none"> · Make sure that the tanks are connected correctly. If the wrong tank (e. g. reagent tank containing NaOH) is connected to the pump labelled as „H₂O”, NaOH might be dosed while H₂O is expected.

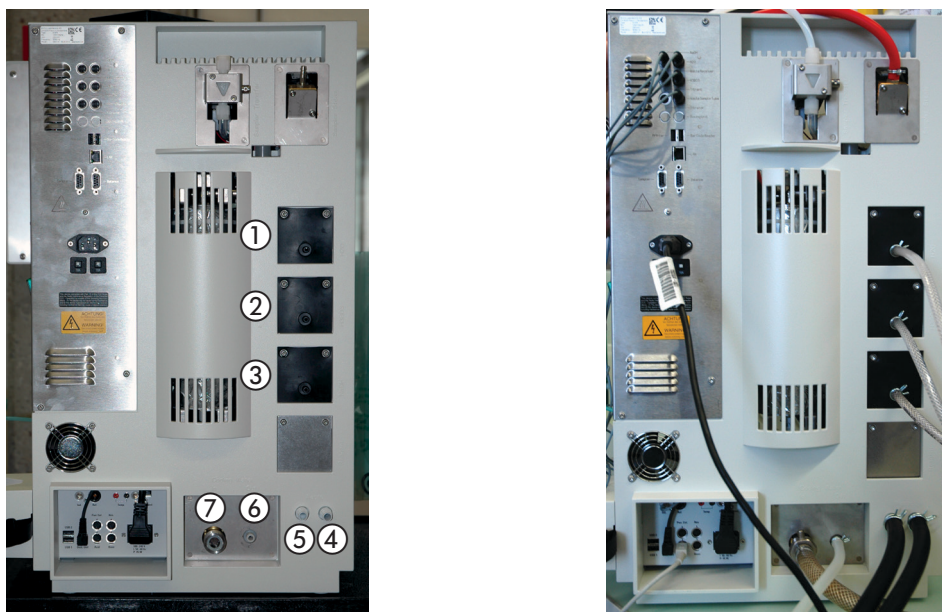

- | | |
|---|------------------------------------|
| ① H ₂ O pump (for steam generator and sample tube) | ④ Waste outlet (receiver waste) |
| ② Boric acid (H ₃ BO ₃) pump | ⑤ Waste outlet (sample tube waste) |
| ③ NaOH pump | ⑥ Cooling water outlet |
| | ⑦ Cooling water inlet |

Fig. 5.5: Reagent, water and waste connections

NOTE:

All pumps are self-priming, no overpressure is necessary at the tanks!

If the sample tube waste and the receiver waste shall be collected in the same tank, the Y-piece (contained in the standard delivery) can be used to merge both tubes.

Cooling water connection

Screw the cooling water hose to the cooling water inlet on the device side and connect it to the water supply. The water pressure should not exceed 4 bar and the cooling water temperature should not exceed 25 °C. The flanged screw coupling for the water connection has a standard screw thread of G 3/4".

Drain cooling water

Place the drain hose for the cooling water directly into the drain (sink). For this purpose, shorten the silicone hose to the optimal length.

Make sure that the drain hose has no kinks and sharp bends.

Secure the drain hose to avoid any flooding inside or in the vicinity of the instrument.



Fig. 5.6: Guidance of the two outlets into one hose



Waste/aspiration hoses

The sample residue can be aspirated and collected separately from the receiver waste. For this purpose a separate collection tank is necessary. For joint disposal of the sample tube and the receiver waste the delivered y-piece is used to guide the two hoses into one hose. All connections must be secured by clamps.



Fig. 5.7: Connection of the drain hose using the straight connector

The collection tank must be located lower than the device to guarantee proper drainage. Connect the waste hose to the waste outlets and secure them with clamps. The hose must be cut to appropriate length. The drain hose is then connected to the tank, by means of the straight connector and the screw cap including the sealing. Alternatively the waste hose can also be guided into the sink.

	 WARNING
	<p>Risks and hazards for humans, animals and the environment.</p> <ul style="list-style-type: none"> Make sure to carefully collect any residues that may be hazardous to humans, animals or the environment and to dispose them according to your local laws and regulations.

5.5 Buret unit for titrant



Fig. 5.8: Connection of the FEP hose at the dosing unit

The preinstalled tube for the titrant ② is reaching out of the housing and must be connected to the dosing unit at port "1".

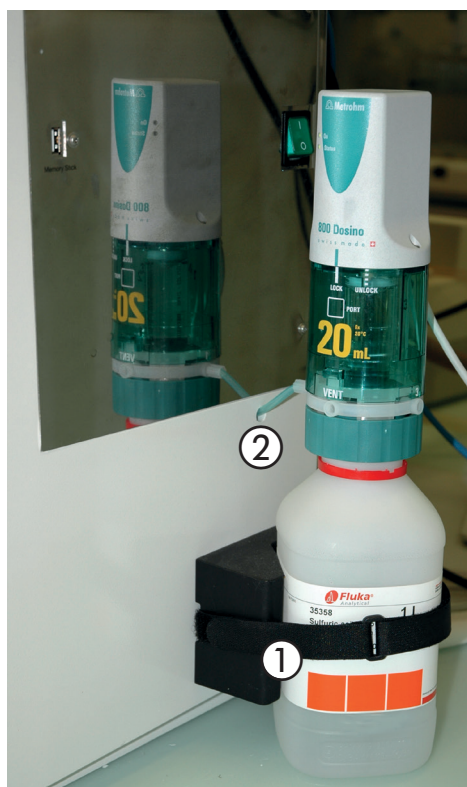

Fig. 5.9: Buret mounted on the titration solution bottle

The bottle containing the titration solution can be fixed on the right side of the device using the provided strap ①. The buret (consisting of the dosing unit and the corresponding drive unit) is mounted on the bottle.

The cable of the driving motor is guided through a cut-out in the housing at the rear side of the K-375 and must be connected to port “Acid” (see chapter 5.2.1).



Fig. 5.10: Guidance of the cable through the cut-out

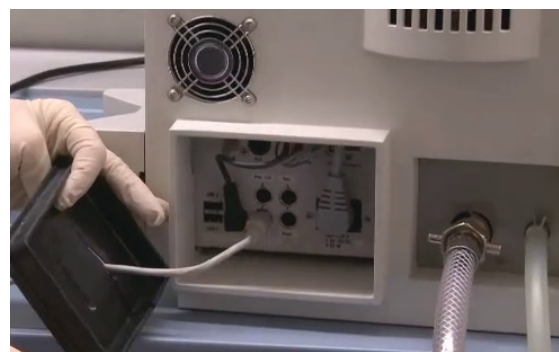

Fig. 5.11: Connection of the cable of the driving motor

The cable of an additional dosing unit for back titration can also be guided through the same cut-outs in the housing.

NOTE

In case the buret gets blocked, refer to chapter 7.7.6 “Troubleshooting the dosing unit”. The assembly of the dosing unit is explained in detail in the separate operating instructions delivered together with the dosing unit.

5.6 Positioning of the dosing tip

Mount the spacer onto the titrant dosing tip to adjust the positioning of the outlet and place it in the receiving vessel. It should be positioned in the same height as the stirrer.



Fig. 5.12: Mounting of the spacer at the dosing tip

NOTE

The dosing tip must not touch the bottom of the receiving vessel, as this would block the outlet.

5.7 Storage tank connection

To connect the storage tanks, proceed as follows:

- Cut the Nylflex tube into pieces to the appropriate length.
- Insert a PTFE suction tube into the Nylflex tube.
- Push a EPDM sealing ring over the Nylflex tube.
- Now fasten the tubes to the tank with the red screw cover.

The storage tanks should not be positioned higher than the device itself and not lower than 1 meter below the instrument.

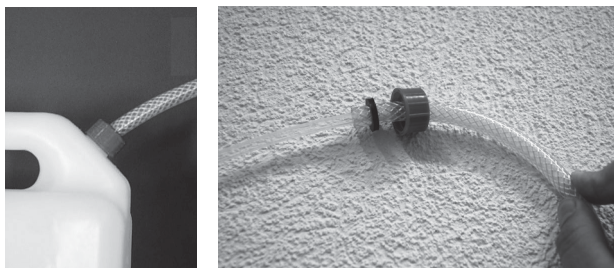



Fig. 5.13: Tank connection

All pumps are self-priming, no overpressure is necessary at the tanks.

	NOTICE
	<p>Risk of device damage by calciferous water or wrong rrong connected tanks.</p> <ul style="list-style-type: none"> · Use only distilled water for the H₂O storage tank to keep the steam generator maintenance-free. · Make sure that the tanks are connected correctly. If the wrong tank (e. g. reagent tank containing NaOH) is connected to the pump labelled as „H₂O“, the steam generator will get damaged.

5.8 Level sensors

Four capacitive level sensors are contained in the standard delivery of the instrument. Three are intended for the storage tanks (NaOH, H₃BO₃ and water) and one for the waste collection tank (either the sample tube or receiver waste). Additional level sensors are available as optional equipment. Each individual sensor is connected to the corresponding socket on the rear side of the device (see section 5.2.1).

The sensitivity of the capacitive level sensors can be adjusted to safely detect the liquid level, if necessary.

Assemble the level sensors according to the following picture:

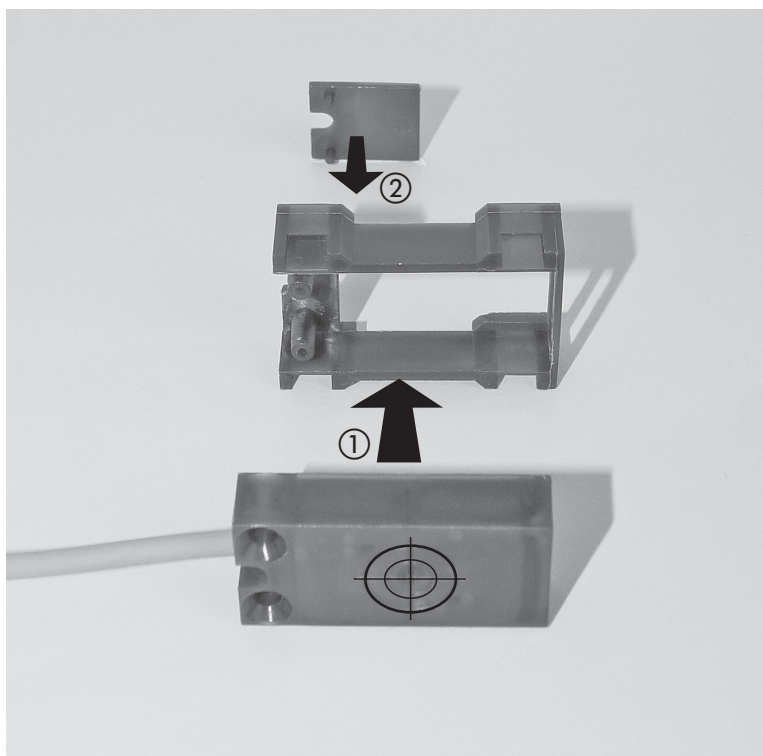

Fig. 5.14: Assembly of the level sensors

- Mount the sensor at the tank using the provided O-ring (see ① in figure 5.9) and connect it at the rear-side of the device to the corresponding port (NaOH, H₂O, H₃BO₃, Waste Sample Tube, Waste Receiver, or Titrant). **The sensitive side of the sensor (marked with the crosshair) has to face the tank!**
- Make sure the tank is filled with the corresponding liquid.
- Shift the sensor together with the rubber strap until it is located below the liquid level.

- The red LED at the sensor should now be **off**.
- If the sensor does not safely detect the liquid:
Use a small screwdriver to set the sensitivity (with the small adjustment screw) of the sensor (see ② in figure 5.9).

Rear view: The crosshair marks the sensitive area

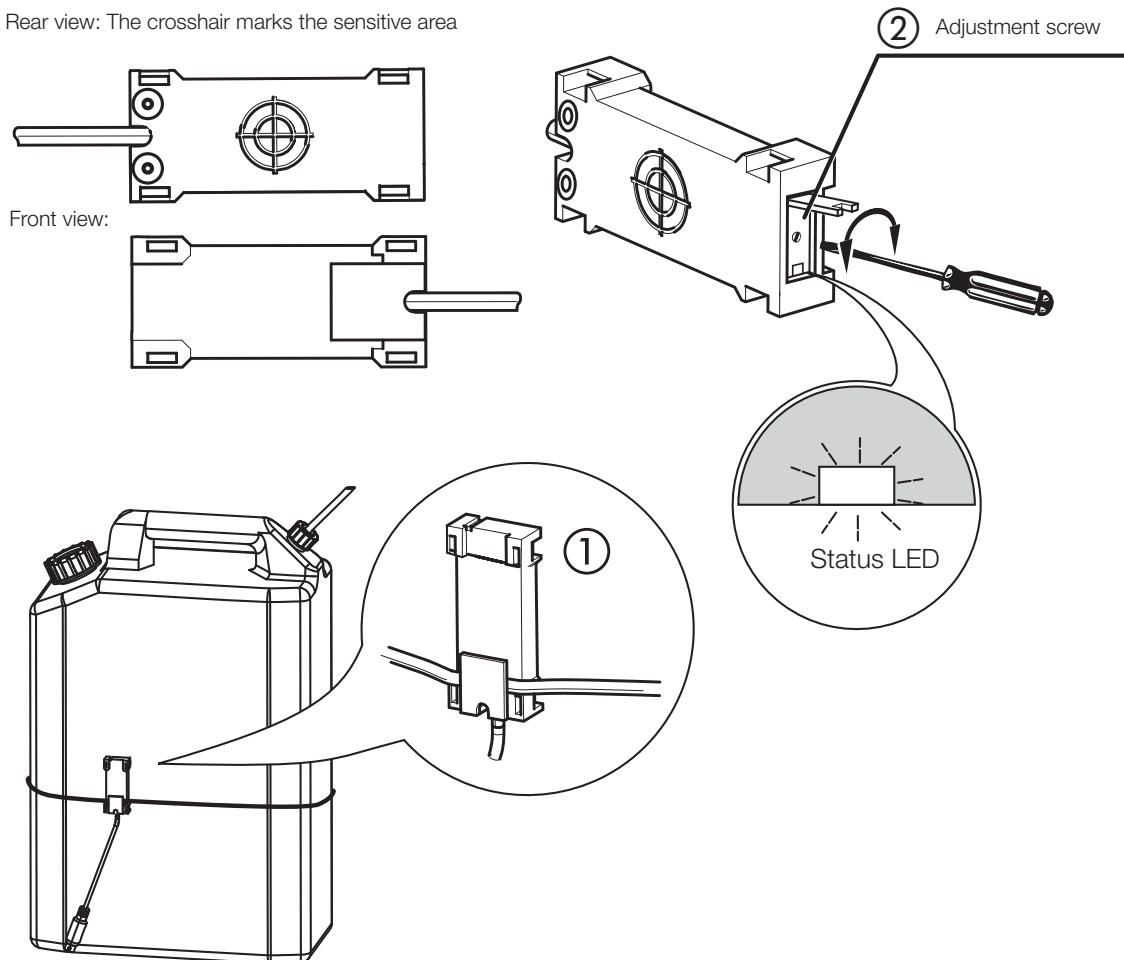

Fig. 5.15: Fixing the level sensors

NOTE

*The sensor detects a liquid when the red LED is **off**.*

The level sensor for the waste tank must be set active within the Settings ► Peripherals screen (See chapter "6.9.1 Settings"). This is not necessary for the other sensors.

5.9 Installation of the titration sensor

Connect the sensor to the cable already mounted.



Fig. 5.16: Connection of the sensor

5.9.1 Potentiometric sensor

Remove the pH electrode from the storage cap and insert it into the receiving vessel. The spacer is used to adjust the positioning. The electrode must not touch the bottom of the receiving vessel, as this could lead to glass breakage. The ideal positioning is 1-2 mm above the bottom of the receiving vessel.

NOTICE

Risk of sensor damage by pushing the electrode with too much pressure onto the bottom of the receiving vessel.

Risk of sensor damage by wrong storage.

Always store the pH electrode in the storage cap in saturated KCl solution (4.2 mol/L). A pH electrode should not be stored dry as this would destroy the diaphragm. If a pH electrode has been stored dry, let it regenerate in saturated KCl for 24 hours or at least overnight prior to further use.

5.9.2 Colorimetric sensor



Fig. 5.17: Colorimetric titration setup

Fit the air bubble trap on the condensate outlet. The wavelength must be adjusted on the optical sensor according to the indicator (Sher: 610nm, bromocresol/methyl red: 640nm); this can be done with a permanent magnet (magnetic mixing rod) on the sensor probe. Clean the optical sensor before use and construct the test setup according to the technical note (335/2018) available on the BUCHI website.

5.10 Connections to peripheral devices

The following devices and accessories can be connected to the K-375:

- up to 6 level sensors for monitoring the liquid level in storage or waste tanks
- a printer (via USB port) for printing e.g. results or methods
- a network cable (LAN) for storing data on a network or for communication with the optional available PC software KjelLink
- a sampler K-376 / K-377 for automatic determinations of sample sequences
- a balance for the automatic acquisition of the sample weight
- a bar code reader for capturing sample data like IDs or batch numbers
- an additional external dosing unit for back titration

5.10.1 Connecting a printer

The K-375 supports printers with USB port and language PCL 3 or higher (PCL 5e, PCL 6, PCL 7 etc. e.g. from Hewlett Packard).

The printer is connected to the USB port marked with “Printer” (position ⑤ in Fig. 5.1).

If the K-375 is connected to the network, it is also possible to use a network printer.

NOTE

For using the printer make sure to switch on the printer first, followed by the K-375.

5.10.2 Connecting a network cable

Instead of storing data locally on the instrument, it can also be stored on a network place. A network cable can be connected to the device on the LAN port on the rear side. For adapting the network settings refer to chapter “6.9.1 Settings ▶ Network”.

More details regarding the network connection can be found in the document KjelMaster K-375 - Manual - Network Connection, which can be obtained from any authorized BUCHI representative.

5.10.3 Connecting a KjelSampler K-376 or K-377

Connect the KjelSampler K-376 or K-377 to the KjelMaster K-375 by means of the supplied RS232 cable.

5.10.4 Connecting a balance

The connected balance must fulfill the following criteria:

- The balance must be equipped with an RS232 interface and a „print“-button. Otherwise it is not possible to send sample weights to the K-375.
- The RS232 settings of the balance and the K-375 software must correspond.
- The sent command from the balance must have the following string: floating point_unit.

The weight is transferred to and stored in the K-375. Negative values are automatically converted into positive sample weights.

For the configuration of the balance refer to *Settings ▶ Peripherals screen (See chapter “6.9.1 Settings”)*.

5.10.5 Connecting a bar code reader

A USB barcode reader can be used to read in data, e.g. a sample name or the weight of a sample, that is printed in form of a barcode. The barcode reader can be connected to the corresponding USB connector on the rear side of the K-375. (See chapter 5.2.1 “Connections of the K-375”.)

5.10.6 External dosing unit for back titration

The external dosing unit is connected to the port “Base” on the rear side of the instrument. (See position ⑩ in figure 5.1) . For installation and assembly of the dosing unit, refer to the instruction manual of the dosing unit.

NOTE

For optimum performance and minimal fluctuation of the measured values, the dosing tip of the dosing unit with the titrant always has to be placed in position “TITR” of the receiver. The second dosing tip can be placed in any other position!

5.11 Preparing the system

5.11.1 Preparing the software

In general it is recommended to check and adapt **all** device settings, located under HOME ► Settings previous to the first use of the instrument.

Following a selection of the most common settings to be adapted is provided:

Define regional settings

HOME ► Settings ► Regional settings

Choose device language, keyboard layout, and date and time format

Set date and time

HOME ► Settings ► Date and time

Set date, time, and time zone

Define user (optional)

HOME ► Settings ► User administration

Different users with specific user rights can be defined. As long as no user is defined, no user administration will be used. For more details refer to the section “6.3 User concept”.

Check peripherals

HOME ► Settings ► Peripherals

Make sure all connected peripherals are selected and configured.

Specify an import and export path for results and other data

HOME ► Settings ► Import and Export

Data can be exported either to a USB device or to a network data share. If a network data share shall be used, a path needs to be specified.

Depending on your preferred applications and methods the following items have to be defined:

Volumetric solutions

HOME ▶ Volumetric Solutions

Define all solutions that may be used for your applications.

Reference substances (optional)

HOME ▶ Reference Substances

Specify the reference substances together with their theoretical values.

Method (optional)

HOME ▶ Methods

Define a new determination method or modify an existing method if necessary.

Blank Corrections

HOME ▶ Blank Correction

Determine the general behavior of the system with respect to the blank correction.

5.11.2 Preparing the hardware

There are only a few tasks that have to be performed in order to prepare the hardware for the first use:

Calibrate the pumps for H₂O, H₃BO₃ and NaOH

HOME ▶ System Preparation ▶ Pump calibration

- Select the pump to be calibrated (H₂O, NaOH or H₃BO₃).
- Enter the target "Dose volume", e.g. 50 mL.
- Press **START** to start the calibration procedure.
- Measure the actually dosed volume and enter it as calibration volume in the displayed screen. Repeat the calibration procedure, until the measured and the dosed volume correspond.
- An acceptable difference at 50 mL is ±5 mL.

NOTE

H₂O and NaOH can be dosed into the sample tube and then poured for measurement into a graduated cylinder.

The H₃BO₃ can be dosed directly into the receiving vessel and then poured into a graduated cylinder.

Rinsing of the buret and the titration hoses

HOME ▶ System Preparation ▶ Buret functions ▶ Dose

Dose some liquid to a waste vessel to rinse the buret and the titration hoses. Repeat the rinsing, until the whole buret and all the titration hoses are filled with titration solution. Make sure there are no air bubbles in the buret or in the titration hoses.

Calibration of pH electrode

HOME ▶ System Preparation ▶ Calibration pH electrode



Calibrate the pH electrode by following the instructions on the screen (see chapter 6.6.1).

NOTE

We recommend to calibrate the pH electrode regularly (e.g. every day) with buffer solution pH 4 and pH 7.



6 Operation

This chapter gives examples of typical device applications and instructions on how to operate the device properly and safely.

	 CAUTION
	<p>Risk of injury. Never operate the device with damaged glassware.</p>

6.1 The operating principle

The graphical user interface of the K-375 is operated via the touch screen. To select a button or an input element in the dialog window, you simply touch the screen using a soft blunt object or a fingertip.

	 CAUTION
	<p>Risk of injury.</p> <ul style="list-style-type: none"> · Never touch the surface of the touchscreen with pointed or sharp objects! Otherwise the screen might get damaged and splinter.

6.2 The home screen

The central element of the user interface is the home screen:

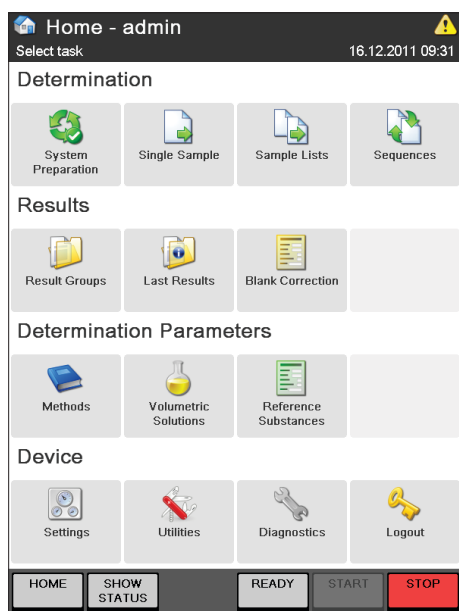















Fig. 6.1: The home screen

The home screen contains 4 different areas with buttons leading to the corresponding dialog windows:

Functional area	Icon	Dialog window	Description

Determination All tasks related to the sample measurement itself (System preparation and sample definition)		System Preparation and manual operation	Perform all tasks related to the preparation of the system, like Preheating, Priming, Cleaning, Aspiration , periodic tasks like electrode calibration or manual tasks related to burets, pumps, and a sampler.
		Single Sample	Determine a single sample based on Type, Name, Method , and (Result-) Group . (Plus additional parameters depending on the sample type.)
		Sample Lists	Create a sample list – a list of samples to be determined one by one without an auto sampler.
		Sequences	Create a sample sequence with predefined samples per rack to be processed using an auto sampler. (Only visible if an auto sampler has been configured under “Settings”.)
Results All tasks related to the results of the system (storage, viewing, printing and selection)		Result Groups	Create and view groups for the storage of your results.
		Last Results	View, print or export the results of the last sample determinations.
		Blank Correction	Calculate mean blanks, enter manual blanks or adapt the settings for the correction of blanks.
Determination Parameters All tasks related to the methods and the used solutions and substances.		Methods	Create, import, edit, and manage your determination methods.
		Volumetric Solutions	Manage all used volumetric solutions.
		Reference Substances	Manage all used reference substances.
Device All tasks related to the device itself. (Settings, Utilities and Diagnostics)		Settings	Adapt all device settings, like date and time, network settings, peripherals, and user management.
		Utilities	Set your backup path for the database backup, use the lab timer or switch to the demo mode of the instrument.
		Diagnostics	Switch to service mode and view or check all relevant system components.
		Logout	Login/Logout to the instrument. (Only visible if User management is used.)

By pressing the **HOME** button on the bottom of each screen you can return to the home screen from any other screen.

6.2.1 The title bar

The title bar is present on top of any screen and consists of the following components:



Fig. 6.2 Title bar

- ① Icon of the current dialog
- ② Title of the current dialog
- ③ System status icon
- ④ Options, hints or help for the current screen
- ⑤ Date & Time

6.2.2 The bottom bar

Like the title bar, the bottom bar is always present on any screen. It consists of 5 different buttons, whose function will never change (there is one exception: the **START** button will be switched to a **PAUSE** button during a running sequence):









Fig. 6.3 Bottom bar

- ① HOME – this button will bring you back to the home screen from any other screen
- ② SHOW/HIDE STATUS – shows or hides the Status view
- ③ READY/STANDBY – toggles the system mode between standby and ready. In standby mode the steam generator is powered off for energy saving reasons.
- ④ START/PAUSE – starts a task, or pause a running sequence
- ⑤ STOP – stops a task.

This button also acts as an EMERGENCY STOP switch. If the device malfunctions or there is an operating error, you can stop all current tasks by pressing the STOP button. (The current will be switched off, resulting in the closure of all valves.)

6.2.3 System status icons

Icon	Meaning
	The device is ready without any restrictions. A sample determination/task can be started.
	A task is running (Determination, Preheating, Cleaning etc.) A sample determination/task can't be started.
	A warning message is shown under Status/Info. Check Status/Info before starting a task. Depending on the cause for the warning, the start button may be inactive.
	There are errors that have to be remedied before a determination can be started (e.g. titrator not ready, dosing unit not connected etc.)
	The device is in standby mode (steam generator switched off, power save mode) – Press READY to return to operating mode.
	Serious error – contact BUCHI service.

Warnings and info messages can be viewed in the **INFO** section of the status view. (Accessible via the button **SHOW/HIDE STATUS** in the bottom bar.)

6.3 User concept

The software distinguishes between three user types with differing access permissions: Administrator (no restrictions), Operator (limited permissions), Lab Manager (limited permissions). Find the detailed user rights in the "KjelMaster K-375: Compliance guide Pharma package" available on the BUCHI website.

NOTE

In case you forgot the password for your administrator account, you can ask your BUCHI service center for a password for the BUCHI Administrator. The account of the BUCHI administrator will always be present on your system and can not be deleted. The password will be valid for one day, enabling the creation of a new administrator account on your system.

6.4 Editable and non-editable menu items

- All menu items with a white background can be viewed, but not edited.
- All menu items, displayed with a grey background can be edited or can be clicked to display further information. A small arrow at the right end of the push button indicates existence of

further screens.

In the example below the **Titer** is the only attribute that may be changed by an operator:

...metric Solutions - HCl 0.5 mol/L	
Select parameter to edit 29.11.2011 13:07	
BACK	
Type	Based on molarity
Molarity	0.500
Valence factor	1
Titer	1.0000
Solution Information	
Last modified	01.01.2011 00:00
Created by	BÜCHI
HOME SHOW STATUS READY START STOP	

Fig. 6.4 Volumetric solutions screen

If an item is editable or not, depends on the rights of the user. All resources that are present by default (standard methods, volumetric solutions, and reference substances) can not be deleted – those items are marked with the symbol of a small padlock.

NOTE

Sample lists and sequences can be locked and unlocked by users with administrator rights therefore the check mark in front of the list or sequence has to be checked and the LOCK button has to be pressed.



Fig. 6.5 Listed item

- ① Check box for selecting an item
- ② Padlock – indicates items that can not be deleted
- ③ Arrow symbol – indicates further screens belonging to the same item

NOTE

To select a larger number of sequenced items proceed as follows:

- check the check box of the first item
- check the check box of the last item by pressing and holding it, until all items in between become automatically selected.

6.5 The status view

The status view of the system is accessible via the **SHOW/HIDE STATUS** button in the bottom bar:

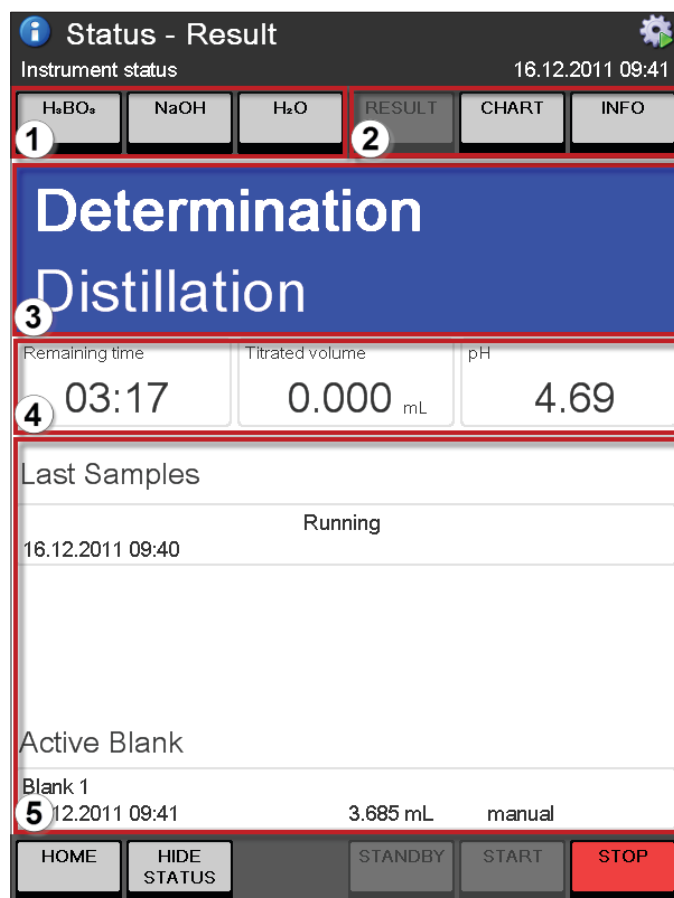

Fig. 6.6 The status view





- ① Buttons for direct dosing of boric acid, sodium hydroxide, and water.

NOTE

The dosed amount per click can be adapted by a user with administrator rights under HOME u SETTINGS u Dosage volume in status view

- ② Buttons for switching between RESULT-, CHART-, and INFO-display.
 ③ Status field – indicates the system status and shows the active step of the running task.
 ④ Progress indication for the running task (remaining time, titrated volume, and measured pH)
 ⑤ Information area – shows last results with the currently active blank, the determination chart or system information.

Colors of the status field

Color of status field	Meaning
	Green – the system is ready for sample determinations.
	Orange – the system is in standby mode. (The steam generator is powered off.)
	Blue – the system is busy (preparative task, periodic task, or sample determination running).
	Red – the system has an error, or a system component is not ready.

6.5.1 RESULT display

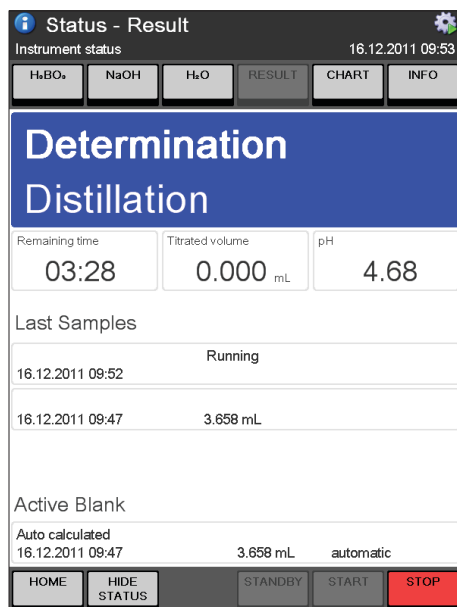

The screenshot shows the 'Status - Result' interface. At the top, it displays 'Instrument status' and the date/time '16.12.2011 09:53'. Below this are navigation tabs for 'H₂BO₃', 'NaOH', 'H₂O', 'RESULT', 'CHART', and 'INFO'. The main display area is titled 'Determination Distillation' in a blue header. It shows three data fields: 'Remaining time' at 03:28, 'Titrated volume' at 0.000 mL, and 'pH' at 4.68. Below these are 'Last Samples' with two entries: '16.12.2011 09:52 Running' and '16.12.2011 09:47 3.658 mL'. An 'Active Blank' section shows 'Auto calculated' at '16.12.2011 09:47' with a volume of '3.658 mL' and mode 'automatic'. At the bottom are control buttons: 'HOME', 'HIDE STATUS', 'STANDBY', 'START', and 'STOP'.

The **RESULT** display of the Status view shows the last 3 results and the currently active blank together with its type and value.

6.5.2 CHART display

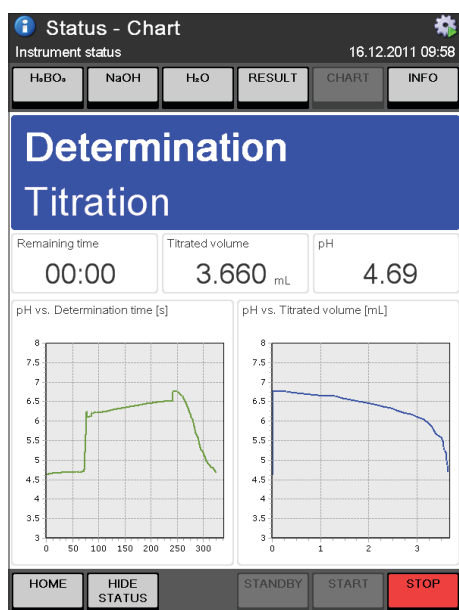

The **CHART** display of the Status view shows two charts:

- pH versus determination time [s] and
- pH versus titrated volume [mL]

NOTE

The charts are only temporarily available and will be overwritten with the charts of the next performed determination. They are excluded from the manual data export. Each result that is exported automatically will always contain the charts.

6.5.3 INFO display

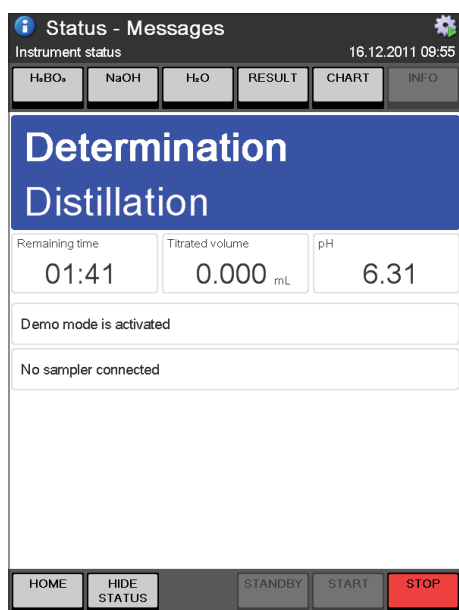



The **INFO** display of the Status view shows all system and error messages.

6.6 Determination

In general there are three different ways for a sample determination with the KjellMaster K-375:

- Determination of single samples (one by one without a sampler)
- Determination of a predefined sample list (one by one without a sampler)
- Determination of a complete rack in a predefined sequence (with a KjellSampler K-376 or K-377)

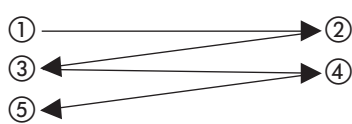
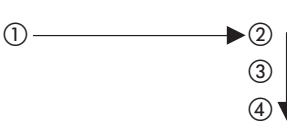
Sample determination possibilities

	Single sample determination	Sample List determination	Sequences (automatic rack determination with sampler)
Recommended for:	<ul style="list-style-type: none"> Only few samples Express sample (e. g. interruption of a group) Method evaluation 	<ul style="list-style-type: none"> Many samples (> 10) Routine analysis Number of samples in a list is variable 	<ul style="list-style-type: none"> Determination with digestion Many samples (> 20) Routine analysis The maximum number of samples in a rack is defined (4 samples for the express and 12 respectively 20 samples for the normal racks)
Operation procedure:	<ol style="list-style-type: none"> 1. Enter data for the first sample 2. Determine the first sample 3. Enter data for the second sample 4. Determine the second sample 5. ... 	<ol style="list-style-type: none"> 1. Enter data for all samples 2. Determine the first sample 3. Determine the second sample 4. ... 	<ol style="list-style-type: none"> 1. Enter data for all samples 2. Determine the first sample 3. Determine the second sample 4. ... 
Description:	Without sampler.	Without sampler.	With KjelSampler K-376 / K-377.

NOTE

Pressing the red **STOP** key on the touchscreen stops all processes immediately.

NOTE

Before starting a sample determination always check the system status icon in the upper right corner of the display to ensure the device is ready for a determination without any restrictions.

The following icon should be displayed:



Other icons may indicate the necessity of preliminary user interaction to prepare the device or to solve problems. For details refer to section "6.2.3 System status icons".

6.6.1 System Preparation



Within the area System Preparation all tasks related to the preparation of the system, like Preheating, Priming, Cleaning, and Aspiration can be defined and performed. In addition periodic tasks like electrode or pump calibration and certain manual tasks related to burets, a sampler, or pH measurement can be performed.

Preparative Tasks

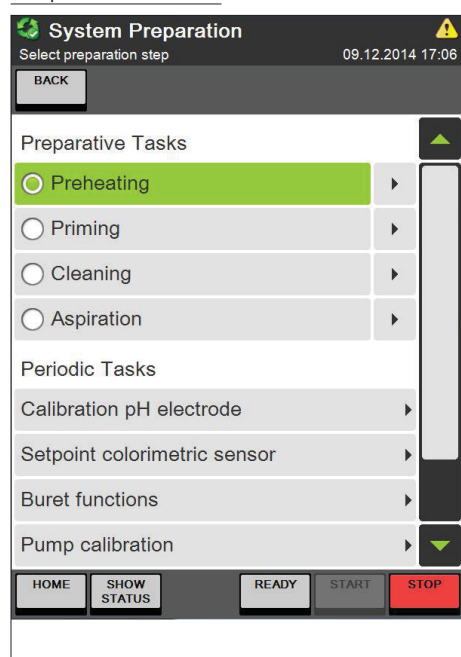

The System Preparation dialog is subdivided in two sections:

Preparative Tasks

- Preheating
- Priming
- Cleaning
- Aspiration

Periodic Tasks

- Calibration pH electrode
- Setpoint colorimetric sensor
- Buret functions
- Pump calibration
- Sampler functions
- Measuring pH or mV

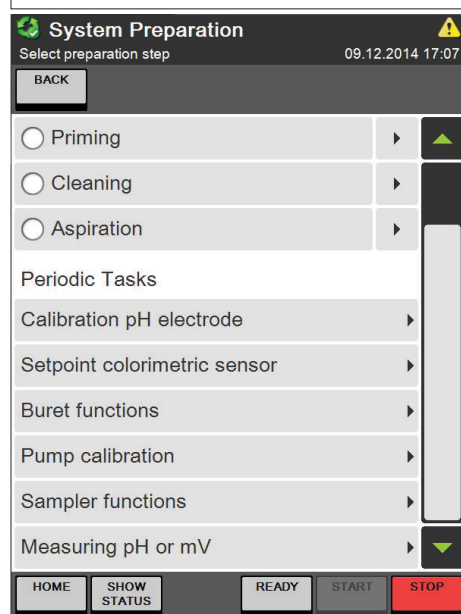

System Preparation - Preheating

Set preheating options 11.01.2012 10:44

BACK

Preheating cycle Unit only

Distillation time 120 s

HOME SHOW STATUS STANDBY START STOP

Calibration pH electrode

It is recommended to calibrate the electrode every day before starting sample determinations. The electrode should be treated according to the recommendation described in the electrode supplementary sheet.

We recommend replacing the electrode, if it does not fulfill the following criteria at 25 °C room temperature anymore:

Slope 95 – 105 %

Zero point pH 6.4 – 7.6

(For pH electrodes other than the ones supplied by BUCHI, additional criteria might be important.)

NOTE

It is recommended to use buffer solutions pH 4.00 and 7.00. (For a 3 point calibration in addition the buffer solution for pH 9.21 is recommended.) Discard buffer solutions after usage. Work with fresh solutions every day.

Setpoint options	
Preheating before setpoint	Yes
Setpoint runs	3
Setpoint cycle	Via sampler
Boric acid	2%
Method	Col. Standard Autosampler
Setpoint	0.0 mV
START MET	impossible

Setpoint colorimetric sensor

It is necessary to determine the Setpoint every day before starting sample determinations, and when the method is changed or fresh chemicals are used to adjust the device to the current conditions.

Before the Setpoint determination a Preheating should be performed to heat up the system.

We recommend a determination of 3 Setpoint cycles before a determination is started. The last Setpoint is used as endpoint for the following determinations.

Select whether the Setpoint cycle should be performed via the KjelSampler or not and the number of cycles. Set the concentration of the boric acid used, the indicator and the method. The selected method for Setpoint determination must be identical to the method used for sample determination.

The Setpoint should fulfill the following criteria:

Deviation between the last two Setpoints should not be more than ± 20 mV.

If Sher indicator is used, you should work with a wavelength of 610nm, in which case the setpoint is in the range of 300 - 500mV.

If bromocresol green/methyl red indicator is used, you should work with a wavelength of 640nm, in which case the setpoint is in the range of 300 - 500mV.

NOTE

To obtain good results, the optical sensor should be used with the setup described in Section 7.2.6. To prevent accumulations of air bubbles on the optical sensor, clean the optical sensor regularly and keep it in the wash solution when not in use.

All Setpoint measurements are stored in Result Groups ▶ Setpoint

Method must be identical to the determination method used for the samples and blanks.

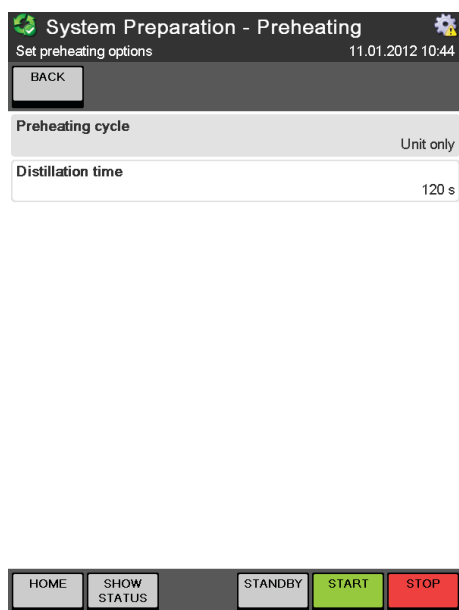

Preheating

The glass parts of the distillation system have to be preheated prior to analysis. This is done by means of a clean and empty sample tube. It is recommended to perform a preheating, when the glassware has cooled down. A status message on the status view will inform the user if preheating is required.

If an auto sampler is configured under “Settings”, select either “Unit only” or “Via Sampler” for “Preheating cycle”.

For “Unit only” only the glassware and tubing of the K-375 device is heated up. With the option “Via Sampler” also glassware and tubing of a connected sampler can be included for the heat-up procedure.

The duration of the preheating procedure (“Distillation

time”) can not be changed.

Press **START** to start the preheating procedure.

System Preparation - Priming
Set priming options 11.01.2012 10:47

BACK FACTORY DEFAULTS

Priming Parameters

Preheating before priming No

Priming runs 1

Priming cycle Unit only

Distillation Parameters

H₂O volume 80 mL

NaOH volume 90 mL

Reaction time 5 s

Distillation mode Fixed time

Distillation time 300 s

Stirrer speed distillation 5

Steam output 100 %

Titration Parameters

Titration type Boric acid titration

Receiving solution volume 60 mL

Titration solution H₂SO₄ 0.25 mol/L

Sensor type Potentiometric

Titration mode Standard

Measuring mode Endpoint pH

Endpoint pH 4.65

Stirrer speed titration 7

Titration start volume 0.000 mL

Titration algorithm Optimal

Aspiration Parameters

Aspiration sample tube Yes

Aspiration receiving vessel Yes

HOME SHOW STATUS STANDBY START STOP

(screenshot stretched)

Priming

Priming is used to prepare the entire system. This preparation procedure includes the distillation and titration with a clean and empty sample tube, as well as the dosing of chemicals. It is recommended to perform a priming at least once a day, before starting analysis. The priming procedure is similar to a sample determination method and can be modified.

Priming Parameters

Select Yes for “Preheating before priming” if prior to the priming procedure a preheating procedure shall be performed.

Set the number of “Priming runs”.

Set “Priming cycle” to “Via sampler”, if the priming procedure should be performed via a present sampler. (Only visible if a sampler has been configured under “Settings”.)

The other parameter sets **Distillation Parameters**, **Titration Parameters**, and **Aspiration Parameters** are just the same like within a method. A detailed explanation can be found in the section “6.8.1 Method”.

Press **START** to start the priming procedure.

Press **FACTORY DEFAULTS** to reset the settings of this screen.

NOTE

If only one priming cycle is selected and no aspiration, no aspiration will be done at all.

If more than one priming cycle is selected and no aspiration, the sample tube and the receiving vessel will be aspirated between the single priming cycles, but not after the last cycle has been performed – instead the system will be stopped after the last run.

System Preparation - Cleaning
Set cleaning options 11.01.2012 10:46

BACK FACTORY DEFAULTS

Cleaning runs	8
H ₂ O volume	300 mL
Distillation time	360 s
Steam output	100 %
Cleaning cycle	Unit only
Aspirate receiving vessel	Yes
Aspirate sample tube	Yes

HOME SHOW STATUS STANDBY START STOP

Cleaning

With regular cleaning, the lifetime of the glass parts can be extended. Thus it is recommended to perform a few cleaning runs before switching off the unit. The cleaning procedure is performed by means of a distillation with water in a clean sample tube. Thus all residues from the last sample determination can be removed.

The volume of water to be used for each cleaning cycle and the number of cleaning cycles can be adapted just like the distillation time in seconds.

The steam output can be set between 30 and 100 %. In case a sampler is present, the Cleaning cycle can be enhanced from “Unit only” to “via sampler” – in this case the hoses from and to the sampler are also cleaned.

Press **START** to start the cleaning procedure.

Press **FACTORY DEFAULTS** to reset the settings of this screen.

NOTE

If only one cleaning run is selected and no aspiration, no aspiration will be done at all.

If more than one cleaning run is selected and no aspiration, the sample tube and the receiving vessel will be aspirated between the single cleaning runs, but not after the last run has been performed – instead the system will be stopped after the last sample.

Aspiration

The aspiration procedure automatically aspirates the sample tube and/or the receiving vessel. All waste liquids of both sources can be collected separately.

Select “Yes” to enable automatic aspiration or “No” to switch off automatic aspiration for the respective vessel.

Press **START** to perform the aspiration.

System Preparation - Aspiration
Set aspiration options 11.01.2012 10:47

BACK

Aspirate sample tube	Yes
Aspirate receiving vessel	Yes

HOME SHOW STATUS STANDBY START STOP

Buret functions

Select the buret function to be performed:

- Prepare,
- Discharge, or
- Dose

Press **START** to start the selected buret function.

NOTE

If more than one buret is connected to the instrument, the respective buret unit (Acid or Base) can also be selected. An additional buret for a base can be connected to the device (e.g. for back titrations) and will be detected automatically during power-on of the instrument.

Pump calibration

Select the pump to be calibrated (H₂O, NaOH or H₃BO₃).

Enter the target "Dose volume", e.g. 50 mL.

Press **START** to start the calibration procedure.

Measure the actually dosed volume and enter it as calibration volume in the displayed screen. Repeat the calibration procedure, until the measured and the dosed volume correspond.

An acceptable difference at 50 mL is ± 5 mL.

NOTE

H₂O and NaOH can be dosed into the sample tube and then poured into a graduated cylinder for measurement.

The H₃BO₃ can be dosed directly into the receiving vessel and then poured into a graduated cylinder.

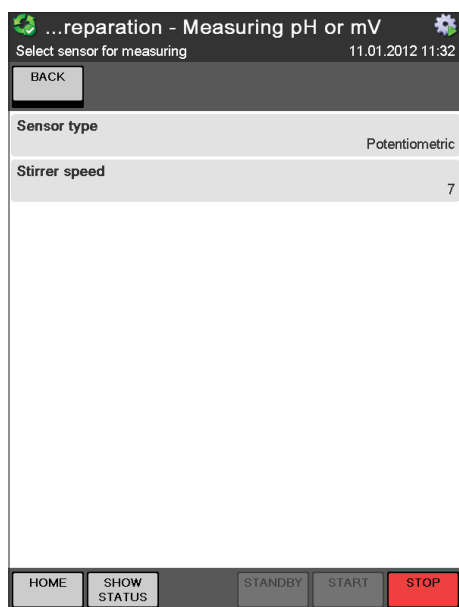
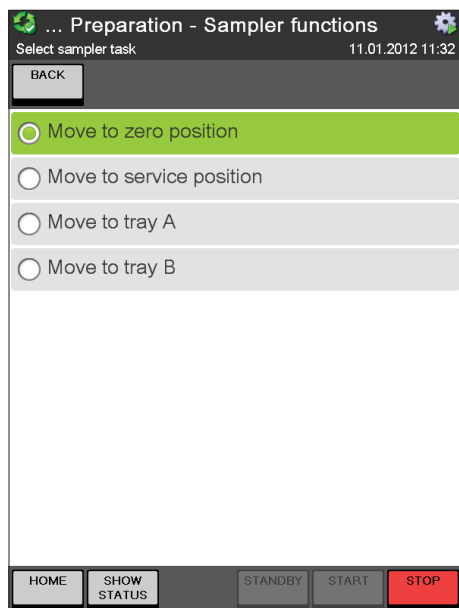

Sampler functions

The actions “Move to zero position” and “Move to service position” are available for both sampler types (1-tray and 2-tray). For a 2-tray sampler the arm is moved to the corresponding zero or service position of the tray, the arm is actually positioned in.

For a 2-tray sampler it is also possible to move the arm of the sampler with “Move to tray A” from tray B to the zero position of tray A and vice versa.

Press **START** to move the arm to the selected position.

Measuring pH or mV

Using this functionality a direct measurement can be performed with the potentiometric or colorimetric sensor.

Select either potentiometric or colorimetric for the “Sensor type”. Adapt the stirrer speed during the measurement to your needs.

Press **START** to start the measurement.

Single Sample



In general four different kinds of samples can be determined:

- **Blanks** (can be used for the correction of sample results).
- **Samples**
- **Reference substances** (results can be rejected if a reference substance is outside of its predefined limits)
- **Control blanks** (to be determined for information only – can not be used for any sample corrections)

The single sample determination is thought for a small amount of samples to be measured without a sampler present.

First of all the sample type has to be selected:

- **Blank,**
- **Sample,**
- **Reference substance** or
- **Control blank.**

According to the selected type of sample, different parameters are available:

For samples of type **Blank**,

press “Name” and enter a name for the blank result.

Press “Method” and select the method to be used for the determination of the blank from the list of the available methods.

Press “Group” and select a result group for the storage of the result from the list of the available result groups. (It is also possible to create a new result group using the **New Group** button.)

Single Sample	
Select sample parameter to edit 02.01.2012 14:02	
BACK	
Type	Sample
Name	Sample 0312
Sample weight	0.0000 g
Protein factor	6.25
Method	Standard Method
Group	Results 3 01-02 2012
HOME SHOW STATUS READY START STOP	

Single Sample	
Select sample parameter to edit 02.01.2012 14:01	
BACK	
Type	Reference substance
Name	
Reference substance	NH ₄ H ₂ PO ₄
Sample weight	0.0000 g
Method	Standard Method
Group	Results 3 01-02 2012
HOME SHOW STATUS READY START STOP	

For samples of type **Sample**,

press “Name” and enter a name for the sample result.

Press “Sample weight” and enter the weight of the sample in [g] or [mL].

Press “Protein factor” and enter the protein factor for the determination of the results.

Press “Method” and select the method to be used for the sample determination from the list of the available methods.

Press “Group” and select a result group for the storage of the result from the list of the available result groups. (It is also possible to create a new result group using the **New Group** button.)

For samples of type **Reference Substance**,

press “Name” and enter a name for the result of the reference substance determination.

Press “Reference substance” and select the reference substance from the list.

Press “Sample weight” and enter the weight of the sample in [g] or [mL].

Press “Method” and select the method to be used for the determination of the reference substance from the list of the available methods.

Press “Group” and select a result group for the storage of the result from the list of the available result groups. (It is also possible to create a new result group using the **New Group** button.)

For samples of type **Control Blank**,

press “Name” and enter a name for the control blank result.

Press “Method” and select the method to be used for the determination of the control blank from the list of the available methods.

Press “Group” and select a result group for the storage of the result from the list of the available result groups. (It is also possible to create a new result group using the **New Group** button.)

6.6.3 Sample Lists



With the sample list functionality it is possible to predefine a complete list of samples to be determined one by one without a sampler. Each sample list can be filled with any number of predefined samples. If all samples of a sample list are selected at once for the determination, they will be determined in the same order they were added to the list. It is also possible to determine the samples in a different order by selecting individual samples from the list.

The type (Blank, Sample, Reference substance or Control blank), and name of each sample can be chosen freely. The same applies for the used method and the result group for the storage of the result.

For samples in addition the weight and the protein factor have to be specified. If a compatible balance is connected to the instrument, the weight of each sample can be automatically taken over from this balance.

NOTE

For each new sample the entries of the previously entered item are used as default values (the default value for the name depends on the type of the sample – in this case the name of the last sample of the same type is taken as default). All default values can be overwritten.

To start a sample list determination you have to enter the list and to select the samples to be determined. To select a complete list simply check the check box in front of the first sample and check and hold the check mark in front of the last sample in the list or use **SELECT ALL**. As a result all samples in between will also be checked. (This will also work for deselecting a larger number of samples.) To exclude samples from the determination uncheck the check mark in front of the sample in question.

Once a sample has been determined (with or without a valid result) it is deleted from the list and the next sample in the list becomes sample number one (the next sample to be determined). After all samples of a list have been processed, the empty list remains on the device (it can either be refilled with samples for the next determinations or deleted manually).

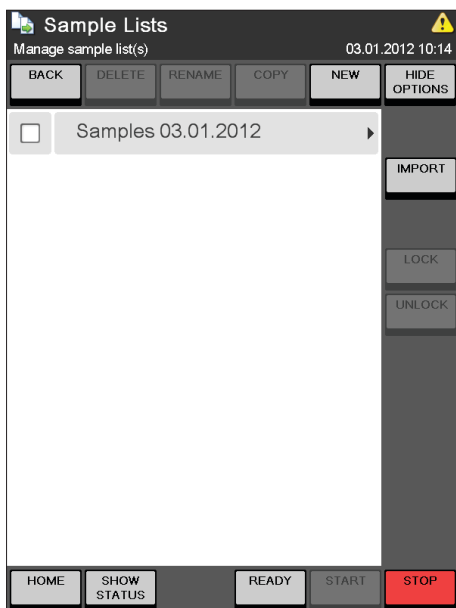

The **Sample Lists** screen shows a list of all present Sample Lists.

New Sample Lists can be created with **NEW** and existing ones can be deleted, renamed or copied.

It is also possible to import sample lists that have been set up on a personal computer from a USB device or a network place.

User with administrator rights can also lock and unlock sample lists.

NOTE

Locked sample lists can not be edited and the contained samples can not be determined but they can be used as template by copying them.

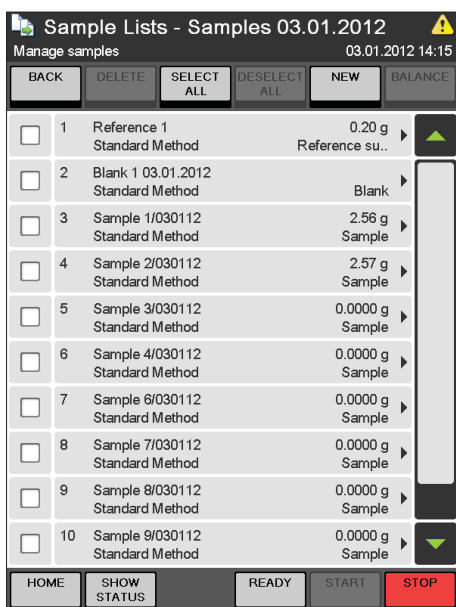

Within each sample list all contained samples are listed together with name, type, method and weight (except blanks, where no weight is needed).

Samples are added to the list with the **NEW** button. Already existing samples can be deleted after being selected.

With the **SELECT/DESELECT ALL** buttons all samples can be selected/deselected at once.

... Samples 03.01.2012 - Position 3
Select sample parameter to edit 03.01.2012 16:06

BACK PREVIOUS POSITION NEXT POSITION NEW

Type Sample

Name Sample 1/030112

Sample weight 2.56 g

Protein factor 6.25

Method Standard Method

Group Results 03.01.2012

Information

Last modified 03.01.2012 13:44

Created by Admin

HOME SHOW STATUS READY START STOP

... Samples 03.01.2012 - Position 1
06.01.2012 13:27

PREVIOUS POSITION NEXT POSITION NEW

Type

Blank

Sample

Reference substance

Control blank

Previous Parameter Cancel OK Next Parameter

HOME SHOW STATUS READY START STOP

When adding a new sample, always a sample of the same type like the previously added sample is added automatically. All parameters of the newly added sample can be adapted. Using the buttons **PREVIOUS/NEXT POSITION** it is possible to navigate from one set of sample parameters to the parameters of the previous or following sample in the list.

The first parameter for each sample is the sample type:

- **Blank,**
- **Sample,**
- **Reference substance** or
- **Control blank.**

Press **NEW** to enter a sample of the selected type on the next position without leaving the screen.

With **OK** the sample is added to the actual position and the sample list is displayed again.

... Samples 03.01.2012 - Position 1 

Select sample parameter to edit 06.01.2012 13:28

BACK PREVIOUS POSITION NEXT POSITION NEW

Type Blank

Name Blank 1 03.01.2012

Method Standard Method

Group Default

Information

Last modified 06.01.2012 13:28

Created by Admin

HOME SHOW STATUS READY START STOP

According to the selected type of sample, a different set of parameters is offered.

For samples of type **Blank**, press “Name” and enter a name for the blank result.

Press “Method” and select the method to be used for the determination of the blank from the list of the available methods.

Press “Group” and select a result group for the storage of the result from the list of the available result groups. (It is also possible to create a new result group using the **New Group** button.)

... Samples 03.01.2012 - Position 3 

Select sample parameter to edit 06.01.2012 13:30

BACK PREVIOUS POSITION NEXT POSITION NEW

Type Sample

Name Sample 1

Sample weight 0.0000 g

Protein factor 6.25

Method Standard Method

Group Default

Information

Last modified 06.01.2012 13:30

Created by Admin

HOME SHOW STATUS READY START STOP

For samples of type **Sample**,

press “Name” and enter a name for the sample result.

Press “Sample weight” and enter the weight of the sample in [g] or [mL].

Press “Protein factor” and enter the protein factor for the determination of the results.

Press “Method” and select the method to be used for the sample determination from the list of the available methods.

Press “Group” and select a result group for the storage of the result from the list of the available result groups. (It is also possible to create a new result group using the **New Group** button.)

... Samples 03.01.2012 - Position 4 

Select sample parameter to edit 06.01.2012 13:30

BACK PREVIOUS POSITION NEXT POSITION NEW

Type Reference substance

Name Reference 1

Reference substance (NH₄)₂SO₄

Sample weight 0.0000 g

Method Standard Method

Group Default

Information

Last modified 06.01.2012 13:31

Created by Admin

HOME SHOW STATUS READY START STOP

For samples of type **Reference Substance**,

press “Name” and enter a name for the result of the reference substance determination.

Press “Reference substance” and select the reference substance from the list.

Press “Sample weight” and enter the weight of the sample in [g] or [mL].

Press “Method” and select the method to be used for the determination of the reference substance from the list of the available methods.

Press “Group” and select a result group for the storage of the result from the list of the available result groups. (It is also possible to create a new result group using the **New Group** button.)

... Samples 03.01.2012 - Position 5 

Select sample parameter to edit 06.01.2012 13:31

BACK PREVIOUS POSITION NEXT POSITION NEW

Type Control blank

Name

Method Standard Method

Group Default

Information

Last modified 06.01.2012 13:31

Created by Admin

HOME SHOW STATUS READY START STOP

For samples of type **Control Blank**,

press “Name” and enter a name for the control blank result.

Press “Method” and select the method to be used for the determination of the control blank from the list of the available methods.

Press “Group” and select a result group for the storage of the result from the list of the available result groups. (It is also possible to create a new result group using the **New Group** button.)

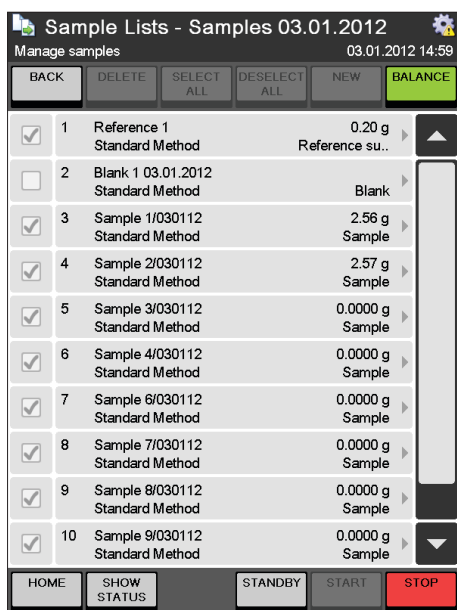

Using the **BALANCE** button the weight of samples can be taken over from a connected balance:

- Select all samples using the **SELECT ALL** button
- Press **BALANCE** – all blanks and control blanks are automatically deselected (no weight is needed for blanks)
- Place the first sample on the balance and press **Enter** on the balance – the first weight is taken over from the balance and entered into the first checked sample in the list.
- Proceed with the next sample
- When all sample weights have been taken over, the balance mode is automatically left.

NOTE

Using a bar code reader it is also possible to read in every sample related data like name or weight from a barcode. The read in data is automatically filled in the active input field.

6.6.4 Sequences



The Sequences button is only available if an auto sampler is present and configured under

Device ▶ Settings ▶ Peripherals ▶ Sampler present

If the sampler has been installed and prepared properly, a sample series to be determined with a one- or two-tray sampler can be defined and pre programmed via a sequence. A sequence contains a number of steps defining the samples itself and the necessary system tasks like preheating, priming, aspiration etc.

The following types of steps may be used within a sequence:

Step	Explanation
Preheating	The preheating procedure is performed according to the settings under System Preparation ▶ Preheating
Priming	The priming procedure is performed according to the settings under System Preparation ▶ Priming
Rack 4	Enter the sample details for a four-place express rack. For a 2-tray sampler the tray position (A or B) can be selected using the SETTINGS button within the step. This step can be edited within the sequence.
Rack 12	Enter the samples for a 12 place rack. For a 2-tray sampler the tray position (A or B) can be selected using the SETTINGS button within the step. This step can be edited within the sequence.

Rack 20	Enter the samples for a 20 place rack. For a 2-tray sampler the tray position (A or B) can be selected using the SETTINGS button within the step. This step can be edited within the sequence.
Pause	The sequence is stopped until it is continued by pressing Start . This step cannot be changed.
Cleaning	The cleaning procedure is performed according to the settings under System Preparation ► Cleaning
Aspiration	The aspiration procedure for the sample tube and the receiving vessel is always performed, unless the aspiration parameters of the referenced method are set to No . (In this case the sample determination will stop after the determination of the sample with the corresponding method.)
Dose H ₃ BO ₃	This step is thought for the protection of the electrode. 50 mL of boric acid are dosed to the receiving vessel to keep the electrode immersed during non-usage of the instrument. This step cannot be changed.
Standby	The device is sent to Standby mode. This step cannot be changed.

NOTE

The order of the steps can not be changed once they have been added to the sequence, but steps can always be deleted and added again in a different order. The tasks Preheating, Priming, and Cleaning are always performed “via sampler”, if used within a sequence. Even if those tasks are set to “unit only” within the area “System Preparation”, this setting will be omitted.

Once started, all samples within a sequence are determined automatically one by one in the working-order of the sampler. Each sequence will be deleted from the sequence list the following day, in case all samples have been determined properly. Sequences containing faulty samples will not be deleted.

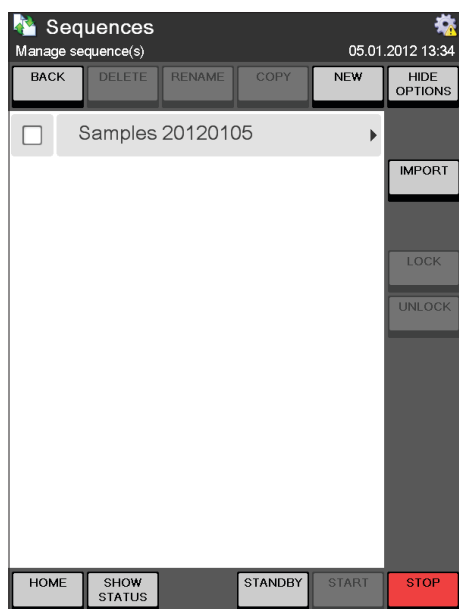

Press the **Sequences** button.

Under **Sequences** a list of all present sample sequences for the sampler is displayed.

New sample sequences can be created with **NEW** and existing ones can be deleted, renamed or copied.

It is also possible to import sample sequences that have been set up on a personal computer from a USB device or a network place.

User with administrator rights can also lock and unlock sample sequences.

NOTE

Locked sequences can not be edited and the determination of the sample sequence can not be started.

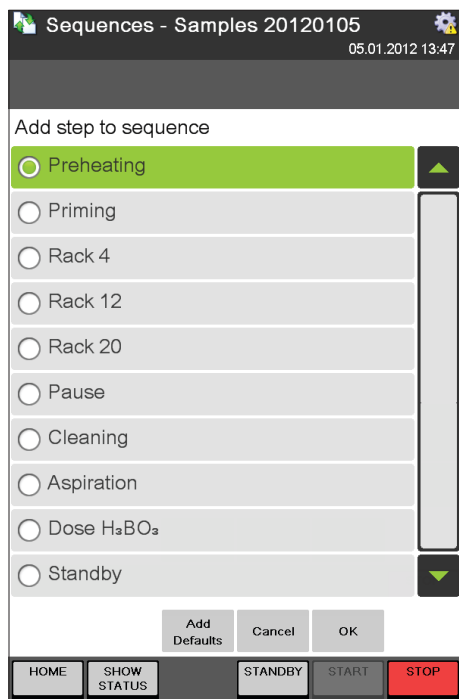

(screenshot stretched)

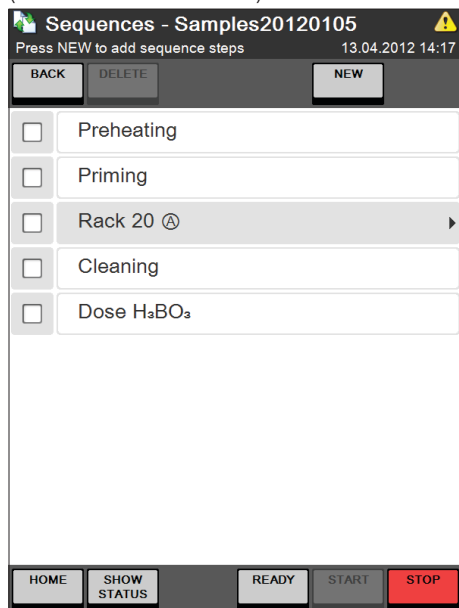

Press **NEW** to create a new sample sequence.

After entering a unique name for the new sequence either a first single step, or a default set of the five commonly used steps can be added to the new sequence (press **Add Defaults** to add the default set of steps or select a single step from the list and press **OK**).

Additional steps can be entered by pressing **NEW**.

NOTE

Since the order of the steps can not be changed afterwards, make sure to add the steps in a reasonable order.

To change the order of steps within a sequence you have to delete selected steps and to add them again in a reasonable order.

NOTE

Except the steps "Rack 4", "Rack 12", and "Rack 20" none of the steps can be changed from within the sequence. (See the table at the beginning of this chapter for details.)

The tasks Preheating, Priming, and Cleaning are always performed "via sampler", if used within a sequence. Even if those tasks are set to "unit only" within the "System Preparation" under "Preparative tasks", this setting will be omitted.

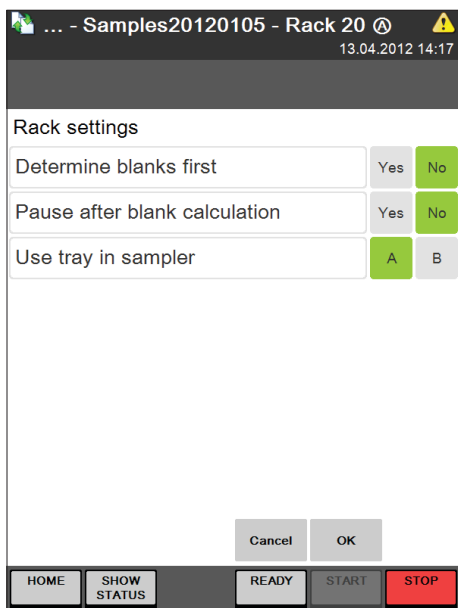

Click on the Rack step to adapt the settings of the rack and to add samples to the rack.

Press **SETTINGS** and adapt the settings for the rack:

“Determine blanks first” Yes/No

(If blanks are determined first, the risk of a cross-contamination can be minimized for the blanks.)

“Pause after blank calculation” Yes/No

A pause after the blank calculation leaves a user with operator rights the chance to eliminate a faulty blank determination from the calculation before any sample determinations are corrected with the calculated blank.

The third setting is only available for 2-tray samplers:

“Use tray in sampler” A/B

Define the position of the rack in the K-377 sampler. The step will be marked with A or B.

The positions of the rack can be filled one by one with samples by clicking on each position.

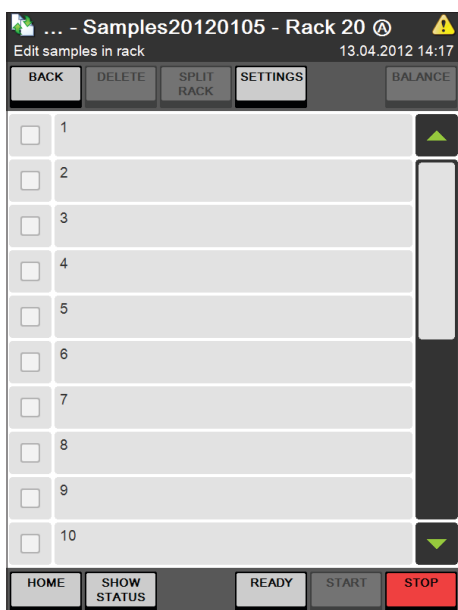

NOTE

*Using the buttons **PREVIOUS POSITION** and **NEXT POSITION** you can switch easily from one sample to the next/previous within each parameter screen. Thus each parameter can be adapted for all samples of the rack in a very easy and convenient way.*

...0120105 - Rack 20 @ - Position 1
View or edit sample 13.04.2012 14:17

PREVIOUS POSITION NEXT POSITION NEW

Type

Blank

Sample

Reference substance

Control blank

Previous Parameter Cancel OK Next Parameter

HOME SHOW STATUS READY START STOP

The first parameter for each sample is the sample type:

- **Blank,**
- **Sample,**
- **Reference substance** or
- **Control blank.**

Press **NEW** to enter a sample of the selected type on the next position without leaving the screen.

With **OK** the sample is added to the actual position and the sample list is displayed again.

(According to the selected type of sample, a different set of parameters is offered.)

...0120105 - Rack 20 @ - Position 1
View or edit sample 13.04.2012 14:17

BACK PREVIOUS POSITION NEXT POSITION NEW

Type Blank

Name Blank 1 13.04.2012

Method Standard Method

Group Default

Information

Last modified 13.04.2012 14:17

Created by Admin

HOME SHOW STATUS READY START STOP

For samples of type **Blank**,

press “Name” and enter a name for the blank result.

Press “Method” and select the method to be used for the determination of the blank from the list of the available methods.

Press “Group” and select a result group for the storage of the result from the list of the available result groups. (It is also possible to create a new result group using the **New Group** button.)

...0120105 - Rack 20 @ - Position 1

View or edit sample 13.04.2012 14:36

BACK PREVIOUS POSITION NEXT POSITION NEW

Type Sample

Name Sample 1 13.04.2012

Sample weight 1.2 g

Protein factor 6.25

Method Standard Method

Group Default

Information

Last modified 13.04.2012 14:31

Created by Admin

HOME SHOW STATUS READY START STOP

For samples of type **Sample**,

press “Name” and enter a name for the sample result.

Press “Sample weight” and enter the weight of the sample in [g] or [mL].

Press “Protein factor” and enter the protein factor for the determination of the results.

NOTE

Using a bar code reader it is also possible to read in every sample related data like name or weight from a barcode. The read in data is automatically filled in the active input field.

Press “Method” and select the method to be used for the sample determination from the list of the available methods.

Press “Group” and select a result group for the storage of the result from the list of the available result groups. (It is also possible to create a new result group using the **New Group** button.)

For samples of type **Reference Substance**,

press “Name” and enter a name for the result of the reference substance determination.

Press “Reference substance” and select the reference substance from the list.

Press “Sample weight” and enter the weight of the sample in [g] or [mL].

Press “Method” and select the method to be used for the determination of the reference substance from the list of the available methods.

Press “Group” and select a result group for the storage of the result from the list of the available result groups. (It is also possible to create a new result group using the **New Group** button.)

...0120105 - Rack 20 @ - Position 2

View or edit sample 13.04.2012 14:36

BACK PREVIOUS POSITION NEXT POSITION NEW

Type Reference substance

Name Reference 1 13.04.2012

Reference substance NH₄H₂PO₄

Sample weight 1.3 g

Method Standard Method

Group Default

Information

Last modified 13.04.2012 14:32

Created by Admin

HOME SHOW STATUS READY START STOP

...0120105 - Rack 20 @ - Position 3 ⚠
 View or edit sample 13.04.2012 14:36

BACK PREVIOUS POSITION NEXT POSITION NEW

Type Control blank

Name Control Blank 1 13.04.2012

Method Standard Method

Group Default

Information

Last modified 13.04.2012 14:32

Created by Admin

HOME SHOW STATUS READY START STOP

Result Groups ⚙
 Groups containing results 09.12.2014 17:14

BACK DELETE RENAME NEW SHOW OPTIONS

Default ▶

Setpoint ▶

Priming ▶

HOME SHOW STATUS STANDBY START STOP

For samples of type **Control Blank**,

press “Name” and enter a name for the control blank result.

Press “Method” and select the method to be used for the determination of the control blank from the list of the available methods.

Press “Group” and select a result group for the storage of the result from the list of the available result groups. (It is also possible to create a new result group using the **New Group** button.)

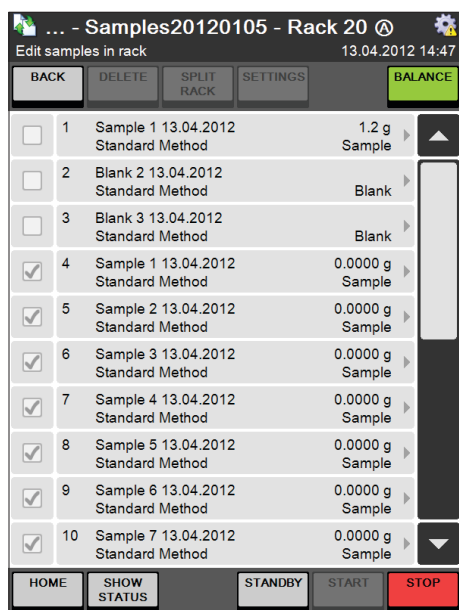

Using the **BALANCE** button the weight of samples can be taken over from a connected balance:

- Select all samples
- Press **BALANCE** – all blanks and control blanks are automatically deselected (no weight is needed for blanks)
- Place the first sample on the balance and press **Enter** on the balance – the first weight is taken over from the balance and entered into the first checked sample in the list.
- Proceed with the next sample
- When all sample weights have been taken over, the balance mode is automatically left.

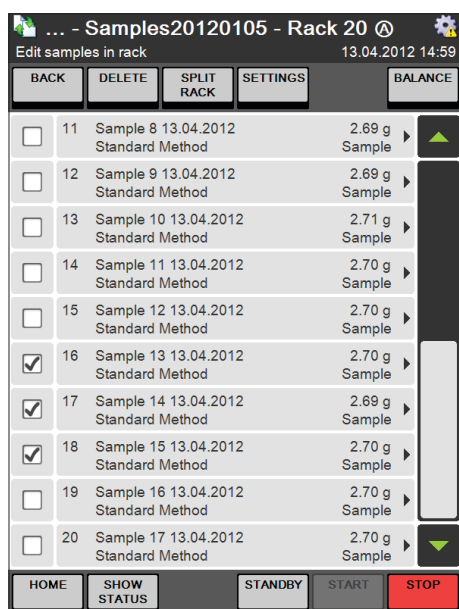

If certain samples of a rack that is already in progress have to be determined immediately this can be done using the **Split Rack** functionality:

Press **PAUSE** to stop the determination of the sequence.

Select the samples to be determined immediately and press **SPLIT RACK**.

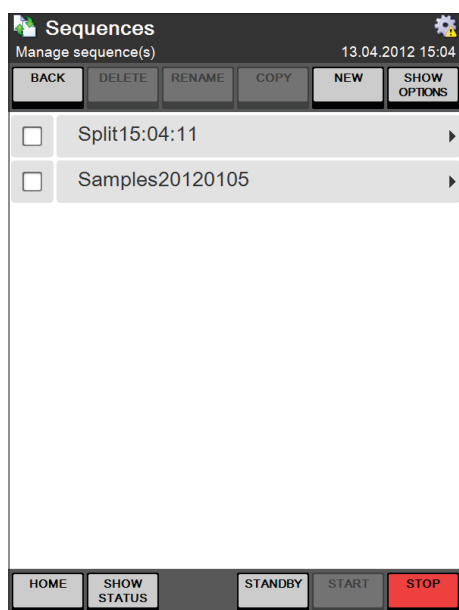

The selected samples will be deleted from the sequence and will be inserted into the rack-step of a new created sequence at the same position of the rack.

The newly created Split-Sequence can be started to determine express samples – afterwards the previous sequence can be continued.

NOTE

Using the button **EDIT MODE** it is possible to edit samples of a rack that is not yet being processed during a running sequence.

6.7 Results

In the result area all tasks related to the results (viewing, printing, and exporting) can be performed.

6.7.1 Result groups



As the name implies, result groups are folders in which results can be stored and grouped in accordance with their properties.

The group a result shall be assigned to can be specified using the corresponding sample parameter “Group” while defining single samples, sample lists or sequences.

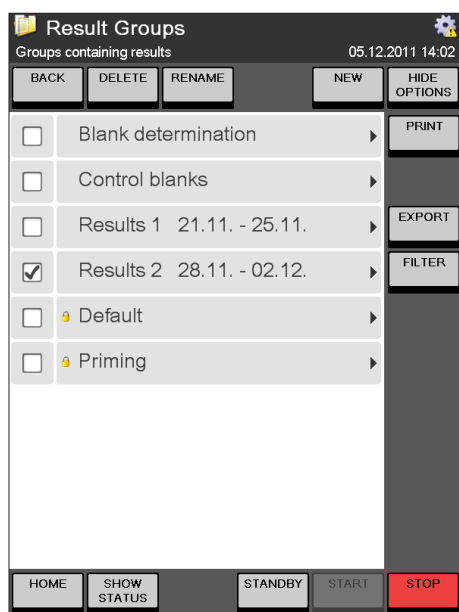

The **Result Groups** screen shows a list of all present groups, available for the storage of results.

Result groups can be created, renamed and deleted by users with administrator rights. User with operator rights are only allowed to create new result groups. Using the **FILTER** button, the list of the Result groups can be filtered with respect to the name and the creation date of the group:

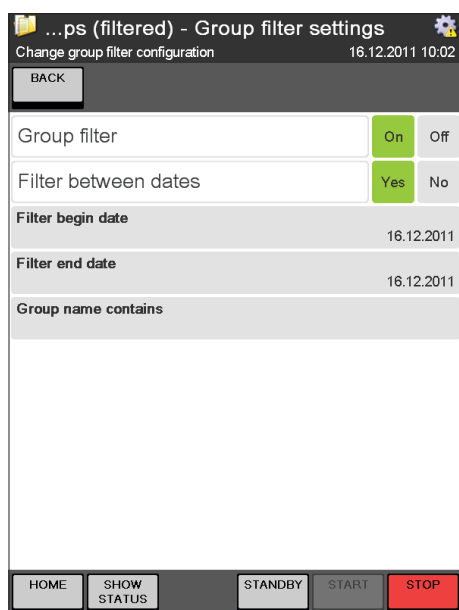

Set the “Group filter” to **On** to filter the list of result groups. Select **Yes** for “Filter between dates” if you wish to filter the list with respect to the creation or rename date and specify a time period using begin and end date.

Specify a part of the group name as filtering criterion using “Group name contains”.

NOTE

All specified filters are correlated using the logical **”AND”** – meaning **every** condition specified in the filter settings must apply in order for a group to match the filter.

Once a filter has been set, the **FILTER** button is switched to **FILTER ACTIVE**:

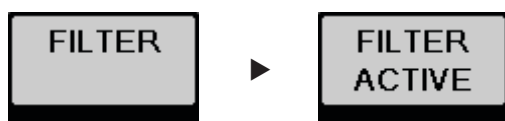

The content of selected groups or selected results can be printed (**PRINT**) or exported (**EXPORT**) to a memory stick or network folder. The path to the network folder and to the target directory on the memory stick can be defined under Settings ► Import & Export (see chapter “6.9.1 Settings”).

Just like the list of the result groups, also the list of the contained results can be filtered. Enter a sample group to set the sample filter:

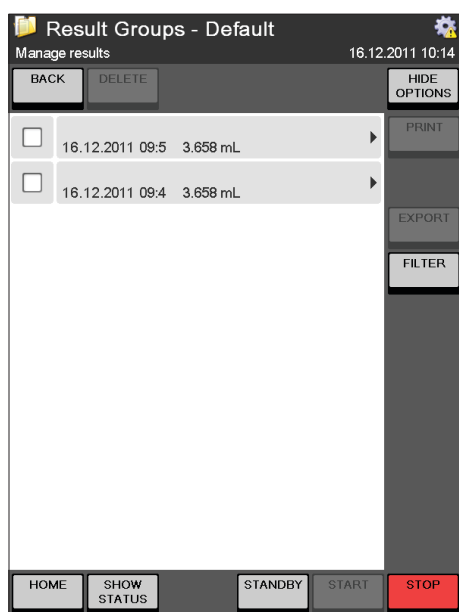

Press **FILTER** to set the sample filter.

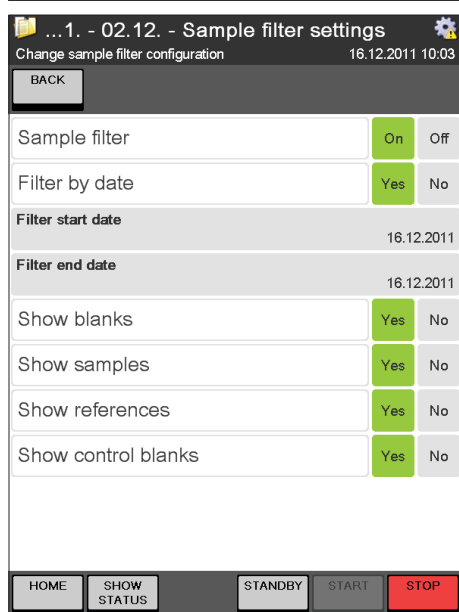

Set the “Sample filter” to **On** to filter the list of displayed results. Select **Yes** for “Filter between dates” if you wish to filter the list with respect to the creation date and specify a time period using begin and end date.

The list of displayed results can be restricted to one or more certain types of results (blanks, samples, references, control blanks).

NOTE

All specified filters are correlated using the logical **”AND”** – meaning **every** condition specified in the filter settings must apply in order for a group to match the filter.

6.7.2 Last Results



The **Last Results** screen shows a list of the last 40 results of the system, regardless to the type of the results.

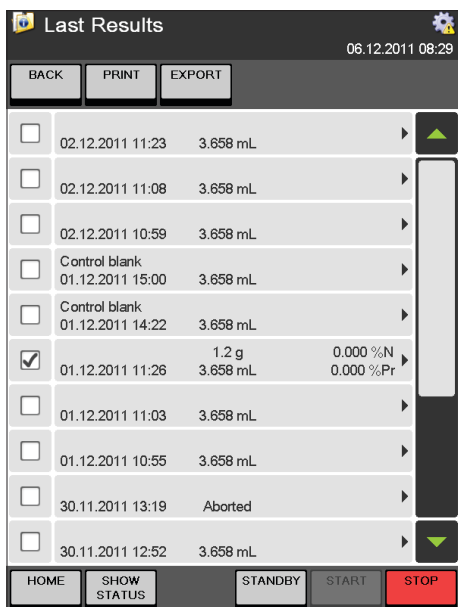

The sample report of selected results can be printed either detailed or short. Results can be exported to a USB stick or a network place.

NOTE

The last results are shown regardless of the result group they are assigned to.

Clicking on a single result opens the detailed sample report:

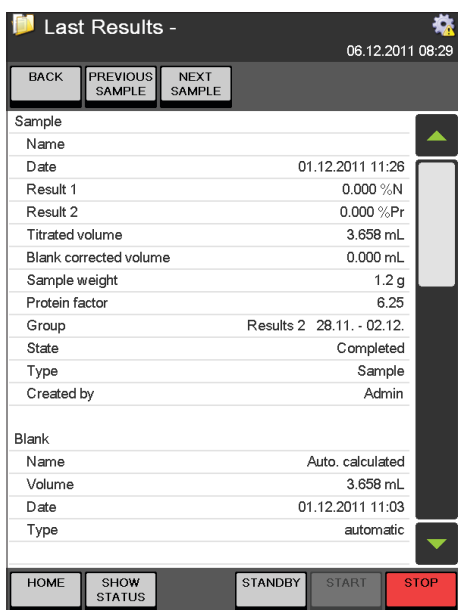

With **PREVIOUS SAMPLE** and **NEXT SAMPLE** you can navigate back and forth within the sample reports of the stored samples.

6.7.3 Blank Correction



The blank correction can be switched on and off:

HOME ► Blank Correction ► SETTINGS



ON Blank correction of results is switched on.

OFF Blank correction of results is switched off – no blank correction at all will be performed.

Within the Blank Correction main screen a list of the latest blanks can be viewed. By adapting the parameter “Blanks in list” under **SETTINGS** it can be determined how many blanks will be shown in this list:



- Will decrease the number of displayed blanks by 10.

+ Will increase the number of displayed blanks by 10.

A maximum number of 90 blanks can be listed.

In general four different possibilities for the determination of the active blank value for the automatic correction of results are available:

- Blank values can be measured (type: measured).
- Blank values can be entered manually (type: manual).
- Blank values can be calculated as mean value of freely selectable measured blanks (type: mean).
- Blank values can be determined automatically by the system (type: automatic).

The type and the value of the blank currently used for result correction is always displayed in the results section of the status view:

SHOW STATUS ► RESULTS (See section 6.5.1)

Entering Manual blanks

To enter a blank value manually (e.g. for a blank value that has not been determined with the instrument), proceed as follows:

Enter the **Blank Correction** screen.

Press **SETTINGS**.

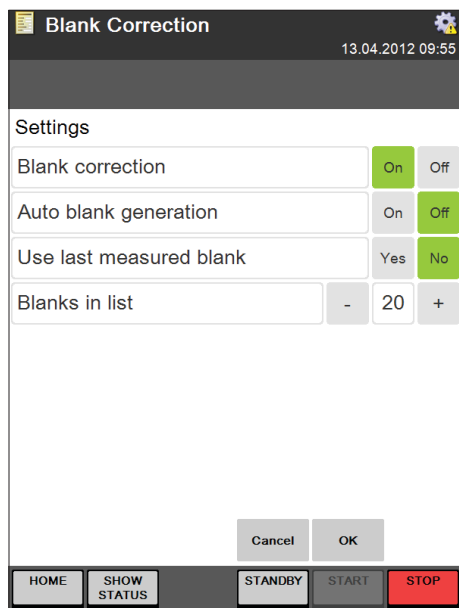

Within the settings for the blank correction,

- switch “Blank correction” **ON**
- switch “Auto blank generation” **OFF**
- select **NO** for “Use last measured blank”
- confirm your settings with **OK**.

Press **MANUAL**

Enter a name for the manual blank value.

Enter the volume for the blank in [mL]

Confirm your settings with **OK**.

The entered blank value is now automatically selected and shown in the list of blanks in the Blank Correction screen.

Manually entered blanks are listed in the blank list with type “manual”.

NOTE

*If you select **Yes** for “Use last measured blank” the next measured value for a sample of Type “Blank” will be used for the correction of all subsequent sample determinations. All sample determinations up to the next blank determination will still be corrected using the currently selected blank value.*

Defining Mean blanks

Mean blank values can be calculated over two or more measured blank values. To define a Mean blank value, proceed as follows:

Enter the **Blank Correction** screen.

Press **SETTINGS**.

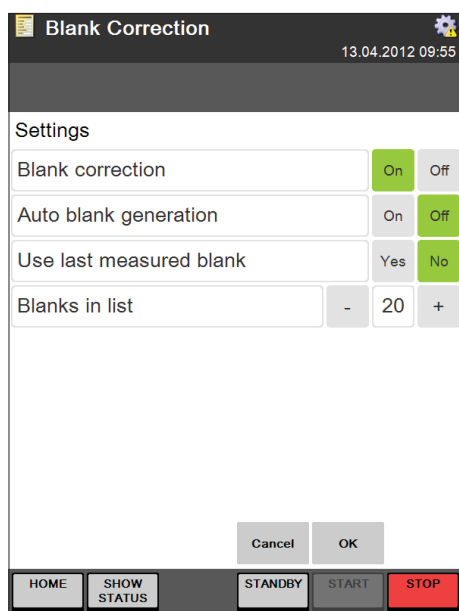

Within the settings for the blank correction,

- switch “Blank correction” **ON**
- switch “Auto blank generation” **OFF**
- select **NO** for “Use last measured blank”
- confirm your settings with **OK**.

Press **MEAN**

Enter a name for the mean blank value.

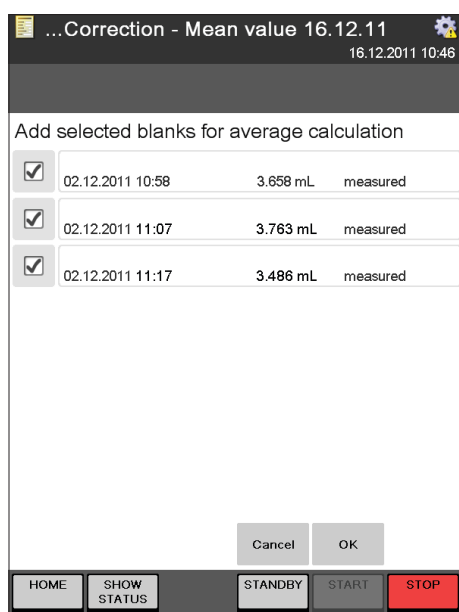

Check the check box of those measured blank values that shall be used for the calculation of the mean value.

Confirm your selection with **OK**.

The calculated mean blank value is now automatically selected and shown in the list of blanks in the Blank Correction screen.

Averaged blanks are listed in the blank list with type “mean”.

NOTE

*If you select **Yes** for “Use last measured blank” the next measured blank value will be used for the correction of all subsequent sample determinations. All sample determinations up to the next blank determination will still be corrected using the currently selected blank value.*

Automatic Blank determination

With automatic blank determination switched on, each continuous row of measured blanks is automatically averaged and the resulting mean value is used for the correction of the subsequently measured sample(s). After one or more samples have been determined, the next measured blank (or the mean of the next measured continuous row of blanks) will be used as active blank value for the correction of the subsequent samples until the next blank is determined.

Automatically determined blanks are listed in the blank list with type “automatic”.

Enter the **Blank Correction** screen.

Press **SETTINGS**.

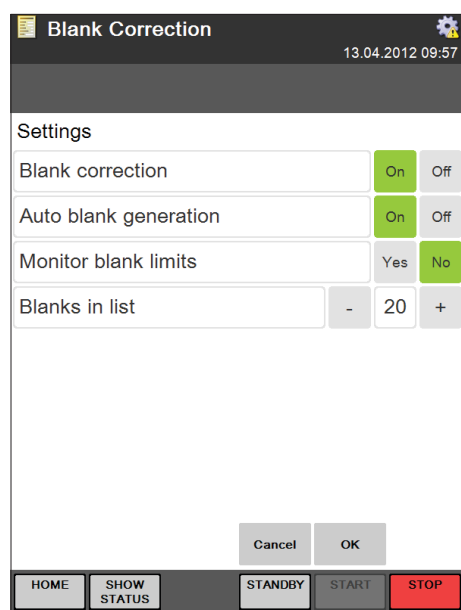

Within the settings for the blank correction,

- switch “Blank correction” **ON**
- switch “Auto blank generation” **ON**
- optionally select **YES** for “Monitor blank limits”

Set the tolerable range for each blank, compared with the mean blank value by defining the Upper and Lower blank limit

- confirm your settings with **OK**.

The currently active blank can be viewed in the **RESULT** display of the status view.

NOTE

*If you select **Yes** for “Use last measured blank“ the next measured blank value will be used for the correction of all subsequent sample determinations. All sample determinations up to the next blank determination will still be corrected using the currently selected blank value.*

Monitoring the blank limits

If the function “Monitor blank limits” is switched on, a tolerable range (defined by the upper- and lower limit in percent) can be defined for an automatically calculated blank value. Each new determined blank that would be part of this calculation, is compared to the already calculated mean value. If the deviation of this blank value is outside of the specified range, the sequence is stopped and a warning message is displayed.

Changing an automatically calculated blank after it was used for sample correction

A user with operator rights is not allowed to change any calculated mean blank value that has already been used for the correction of any results. Since this proceeding would have an impact to the calculated results this option is restricted to users with administrator rights. Each blank that was changed subsequently (after it was used for sample correction) is marked with a “*”.

6.8 Determination Parameters

Within this area, the methods for determinations with the K-375 can be written and the resources like reference substances or volumetric solutions for the titration can be defined and edited. (Once defined, the resources can be referenced from within the method.)

6.8.1 Methods



The structure of the K-375 method is highly flexible and offers all possibilities to create a method that reflects the special needs of the user.

Each method consists of 4 different parameter sets:

- Parameters for the sample distillation
- Parameters for the sample titration
- Parameters for the sample determination (calculating the result)
- Parameters for the aspiration

NOTE

The method does not cover system preparation tasks like Preheating, Priming, and Cleaning – for single samples or sample lists those tasks have to be performed manually previous to a sample determination (See chapter “6.6.1 System Preparation”). For sequences (automated determination of sample racks with a sampler) the system preparation tasks can be defined within the Sample Sequence previous to or after the determination of a complete rack (see chapter “6.6.4 Sequences”).

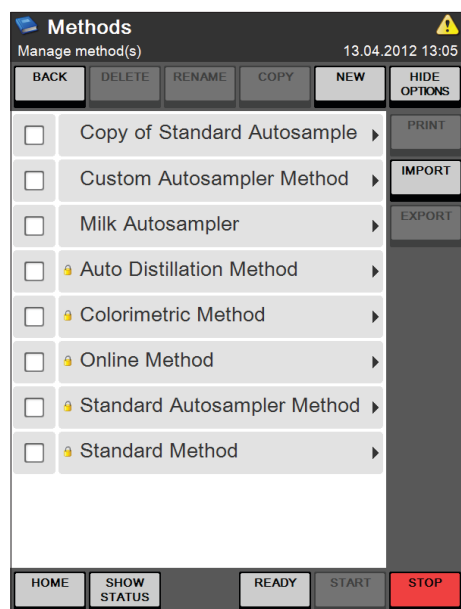

Within the Methods screen, methods can be created, deleted, renamed, copied or printed.

A new method is created using the **NEW** button. The name for a new method has to be unique.

With the buttons **IMPORT** and **EXPORT**, accessible via the **SHOW OPTIONS** button, methods can be imported from, or exported to a memory stick or a network folder.

The path to the network folder and to the target directory on the memory stick is defined under Settings ► Import & Export (see chapter “6.9.1 Settings”).

NOTE

Methods marked with a small padlock are pre-defined and can neither be deleted nor changed. Nevertheless they can be copied and stored as a new method which can be changed.

...ds - Custom Autosampler Method
Set method parameters 13.12.2011 09:37

BACK

Distillation Parameters

H ₂ O volume	80 mL
NaOH volume	90 mL
Reaction time	5 s
Distillation mode	Fixed time
Distillation time	300 s
Stirrer speed distillation	5
Steam output	100 %

Titration Parameters

Titration type	Boric acid titration
Receiving solution volume	60 mL
Titration solution	H ₂ SO ₄ 0.25 mol/L
Sensor type	Colorimetric
Titration mode	Standard
Measuring mode	Endpoint pH
Endpoint pH	4.65
Stirrer speed titration	7
Titration start volume	0.000 mL
Titration algorithm	Optimal

Determination Parameters

Determination mode	Standard
Unit result 1 (mass)	%N
Unit result 1 (volume)	g N/L
Unit result 2 (mass)	%Pr
Unit result 2 (volume)	g Pr/L

Aspiration Parameters

Aspiration sample tube	Yes
Aspiration receiving vessel	Yes

Method Information

Last modified	13.12.2011 09:37
Created by	Admin

HOME SHOW STATUS STANDBY START STOP

The different areas of the method are separated from each other by the corresponding heading. The Method Information section at the bottom of each method provides information about the last modification date and the creator of the method.

Distillation Parameters

With the distillation parameters all necessary steps for the distillation can be adapted:

- Step 1: Dilution with H₂O**
Step 2: Alkalization with NaOH solution
Step 3: Steam distillation

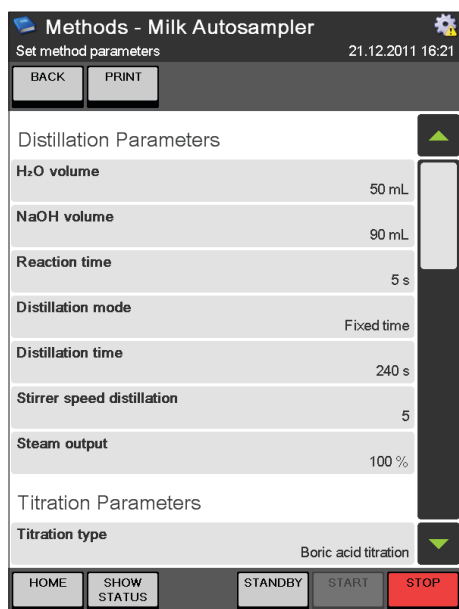

Parameters for Step 1 and 2

(dilution and alkalization)

Click on “H₂O volume” to specify the volume of water that shall be used for the dilution of the sample.

Click on “NaOH volume” to specify the volume of the sodium hydroxide solution that shall be used for the alkalization of the sample. (The concentration of the sodium hydroxide solution doesn't need to be specified within the instrument. For BUCHI applications a solution of 32 % NaOH is recommended.)

A reaction time for the alkalization can be specified via the “Reaction time” button. (Also to allow the solution to cool down again after the exothermic neutralization.)

Parameters for Step 3 (Steam distillation)

For the mode of the steam distillation either **Automatic (IntelliDist)** or **Fixed time** can be selected. **Automatic (potentiometry only):** The countdown of the specified distillation time is not started until the first amount of nitrogen reaches the receiver vessel (indicated by an increase of the pH value). The variable heat-up time is excluded from the distillation time. Each measurement leads to a reliable result – regardless if performed with a cooled down or a preheated instrument. This mode is recommended for all samples containing more than 1 mg of nitrogen. The automatic mode cannot be used with colorimetric titrations.

Fixed time (potentiometry and colorimetry): The countdown of the specified distillation time starts at the same time the distillation is started. Measurements with a cooled down device will need a longer heat-up time, which will be part of the specified distillation time. This mode (together with previous preheating and priming steps) is recommended for all samples containing less than 1 mg of nitrogen.

Methods - Milk Autosampler
Set method parameters 21.12.2011 16:21

BACK PRINT

Distillation Parameters

H ₂ O volume	50 mL
NaOH volume	90 mL
Reaction time	5 s
Distillation mode	Fixed time
Distillation time	240 s
Stirrer speed distillation	5
Steam output	100 %

Titration Parameters

Titration type Boric acid titration

HOME SHOW STATUS STANDBY START STOP

After selecting the “Distillation mode”, enter the distillation time, the stirrer speed during the distillation, and the steam output in percent (between 30 and 100 %).

Titration Parameters

Depending on the application either a **back titration** or a **boric acid titration** can be performed. BUCHI recommends the use of the boric acid titration.

If no titration at all shall be performed, **None** can be selected for the parameter “Titration type”. The boric acid titration can be performed either with a potentiometric or a colorimetric sensor – for the back titration only the potentiometric sensor can be used.

Methods - Milk Autosampler
Set method parameters 22.12.2011 10:55

BACK PRINT

Stirrer speed distillation 5

Steam output 100 %

Titration Parameters

Titration type None

Aspiration Parameters

Aspiration sample tube	Yes
Aspiration receiving vessel	Yes

Method Information

Last modified 22.12.2011 10:55

Created by Admin

HOME SHOW STATUS STANDBY START STOP

Select None for the “Titration type”, if no titration at all shall be performed.

... of Standard Autosampler Method

Set method parameters 13.04.2012 10:35

BACK

Titration Parameters

Titration type Back titration

Receiving solution H₂SO₄ 0.25 mol/L

Receiving solution volume 60 mL

Titration solution NaOH 0.1 mol/L

Sensor type Potentiometric

Titration mode Standard

Measuring mode Endpoint pH

Endpoint pH 4.65

Stirrer speed titration 7

Titration start volume 0.000 mL

Titration algorithm Optimal

HOME SHOW STATUS READY START STOP

Parameters for Back titration (potentiometry only)
Select **Back titration** for the parameter “Titration type”.

For the back titration the ammonia is collected in a receiving solution of a strong acid. Afterwards the remaining amount of the acid, that has not been consumed for the neutralization of the ammonia, is titrated back with a strong base. Therefore it is important that the receiving acid solution is dosed accurately.

NOTE

An additional second external dosing device must be connected to the device to facilitate the accurate addition of the receiving acid solution.

The receiving solution (strong acid) and the corresponding titrant (strong base) can be selected from the Volumetric solutions list (see chapter “6.8.2 Volumetric Solutions”). The exact amount of the provided receiving solution can be entered using the “Receiving solution volume” parameter. In addition the stirrer speed for the titration and a titration start volume can be specified. The specified titration start volume is dosed into the receiving vessel previous to the titration. (The sensor type cannot be changed for the back titration.)

With the parameter Titration algorithm one of two available algorithms for the titration can be selected:

Optimal: This algorithm has been optimized with respect to the duration of the titration and the accuracy of the result. It is recommended to use the optimal algorithm for back titrations of samples with a low nitrogen content.

Normal: This algorithm has been optimized with respect to the accuracy of the result but will require a longer time than the optimal algorithm. The normal algorithm is recommended for samples with high nitrogen content and when using titration solutions with high concentration (e.g. 0.5 N).

...y of Custom Autosampler Method
Set method parameters 13.04.2012 10:56

BACK

Titration Parameters

Titration type Boric acid titration

Receiving solution volume 60 mL

Titration solution H₂SO₄ 0.25 mol/L

Sensor type Colorimetric

Stirrer speed titration 7

Titration start volume 0.000 mL

Titration algorithm Optimal

Determination Parameters

Determination mode Standard

HOME SHOW STATUS STANDBY START STOP

Parameters for Boric acid titration with colorimetric sensor

Select **Boric acid titration** for the parameter “Titration type”. The volume of the boric acid to be dosed into the receiving vessel can be specified and the **titration solution** can be selected from the titration solutions list (see chapter “6.8.2 Volumetric Solutions”).

Select **Colorimetric** for the parameter “Sensor type”.

For the “Titration mode” either Online or Standard can be selected:

Online: The titration is already started, while the distillation is running. With the parameter “Titration start time” a delay time for the titration start can be defined. It is recommended to set a delay of 90 seconds.

Standard: The titration is started sequential after the distillation is finished.

Furthermore the stirrer speed for the titration and a titration start volume can be specified. The specified titration start volume is dosed into the receiving vessel at the beginning of the titration when samples are analyzed

With the parameter “Titration algorithm” one of two available algorithms for the titration can be selected:

Optimal: This algorithm has been optimized with respect to the duration of the titration and the accuracy of the result. It is recommended for samples with a higher nitrogen content.

Normal: This algorithm has been optimized with respect to the accuracy of the result but will require a longer time than the optimal algorithm. The normal algorithm is recommended for samples with low nitrogen content and when using titration solutions with high concentration (e.g. 0.5 N).

The screenshot displays the 'Methods - Milk Autosampler' interface. At the top, it shows 'Set method parameters' and the date/time '22.12.2011 10:51'. Below this are 'BACK' and 'PRINT' buttons. The main area is titled 'Titration Parameters' and contains the following settings:

Titration type	Boric acid titration
Receiving solution volume	60 mL
Titration solution	H ₂ SO ₄ 0.25 mol/L
Sensor type	Potentiometric
Titration mode	Standard
Measuring mode	Endpoint pH
Endpoint pH	4.65
Stirrer speed titration	7
Titration start volume	0.000 mL
Titration algorithm	Optimal

At the bottom of the screen, there are five buttons: 'HOME', 'SHOW STATUS', 'STANDBY', 'START', and 'STOP'.

Parameters for Boric acid titration with potentiometric sensor

Select **Boric acid titration** for the parameter “Titration type”. The volume of the boric acid to be dosed into the receiving vessel can be specified and the titration solution can be selected from the Volumetric solutions list (see chapter “6.8.2 Volumetric Solutions”).

Select **Potentiometric** for the parameter “Sensor type”.

For the “Titration mode” either **Online** or **Standard** can be selected:

Online: The titration is already started, while the distillation is running. With the parameter “Titration start time” a delay time for the titration start can be defined.

Standard: The titration is started sequential after the distillation is finished.

With the parameter “Measuring mode” the determination method for the endpoint of the titration can be determined:

Startpoint: the endpoint pH value is determined by a measurement of the boric acid in the receiving vessel previous to the distillation process.

Endpoint: the endpoint pH value can be entered as number using the parameter “Endpoint pH”.

Furthermore the stirrer speed for the titration and a titration start volume can be specified. The specified titration start volume is dosed into the receiving vessel at the beginning of the titration when samples are analyzed.

With the parameter “Titration algorithm” one of two available algorithms for the titration can be selected:

Optimal: This algorithm has been optimized with respect to the duration of the titration and the accuracy of the result. It is recommended for samples with a higher nitrogen content.

Normal: This algorithm has been optimized with respect to the accuracy of the result but will require a longer time than the optimal algorithm. The normal algorithm is recommended for samples with low nitrogen content and when using titration solutions with high concentration (e.g. 0.5 N).

Determination Parameters

With the determination parameters the Determination mode (either “Standard” or “Direct distillation”) can be determined.

In addition two sets of result units (each set consisting of one mass- and one volume-related unit) can be selected for the standard determination mode.

... of Standard Autosampler Method
Set method parameters 13.04.2012 11:08

BACK

Determination Parameters

Determination mode Direct distillation

Direct distillation factor 1.00

Regression factor 1.00

Aspiration Parameters

Aspiration sample tube Yes

Aspiration receiving vessel Yes

Method Information

Last modified 13.04.2012 11:07

Created by Admin

HOME SHOW STATUS STANDBY START STOP

Click on “Determination mode” and select either “Standard” for a determination with a previous digestion or “Direct distillation” for a determination without previous digestion.

For a direct distillation an additional factor and regression factor can be specified for result calculation.

NOTE

The result for a direct distillation is calculated following the linear equation $y = a \cdot x + b$ where **a** is given by the direct distillation factor and **b** by the regression factor.

... of Standard Autosampler Method
Set method parameters 13.04.2012 13:16

BACK

Determination Parameters

Determination mode Standard

Unit result 1 (mass) %N

Unit result 1 (volume) g N/L

Unit result 2 (mass) %Pr

Unit result 2 (volume) g Pr/L

Aspiration Parameters

Aspiration sample tube Yes

Aspiration receiving vessel Yes

Method Information

HOME SHOW STATUS READY START STOP

The four result units (mass and volume) for the determination mode “Standard” can be adapted by clicking on it and selecting a corresponding unit from the result units list. (See chapter “6.9.1 Settings”)

Aspiration Parameters

After a determination has been completed, the waste in the sample tube and/or in the receiving vessel can automatically be aspirated and transferred into a corresponding waste container:

... of Standard Autosampler Method	
Set method parameters 13.04.2012 13:25	
BACK	
Unit result 1 (mass)	%N
Unit result 1 (volume)	g N/L
Unit result 2 (mass)	%Pr
Unit result 2 (volume)	g Pr/L
Aspiration Parameters	
Aspiration sample tube	Yes
Aspiration receiving vessel	Yes
Method Information	
Last modified	13.04.2012 13:23
Created by	Admin
HOME	SHOW STATUS
READY	START
STOP	

Click on “Aspiration sample tube” and select **Yes** to switch on the automatic aspiration of the sample tube.

Click on “Aspiration receiving vessel” and select **Yes** to switch on the automatic aspiration of the receiving vessel.

NOTE

If you select the automatic aspiration of the sample tube and/or the receiving vessel and the waste is collected, we recommend the use of level detectors for the corresponding waste container(s). The level sensors can be configured within the Settings ► Peripherals screen (See chapter “6.9.1 Settings”)

NOTE

Samples containing bigger particles should not be aspirated as they may cause problems with the valves (leaks and blockages).

6.8.2 Volumetric Solutions



All volumetric solutions that may be used for a titration can be defined in this menu. Once a solution has been defined, it can directly be referenced and used from within a method.

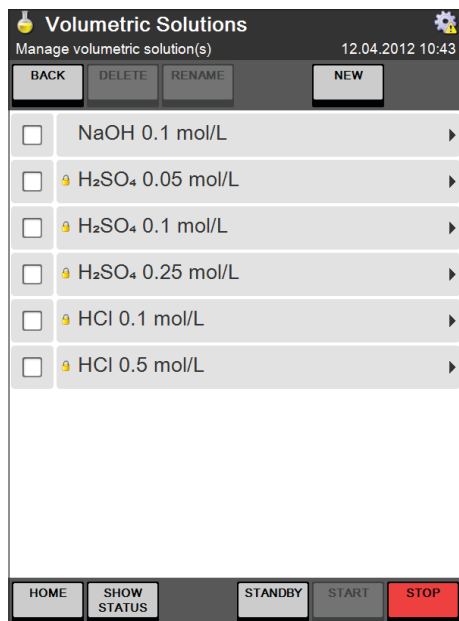

Create a new volumetric solution using a unique name, or delete or rename an existing one.

NOTE

Volumetric solutions marked with a small padlock are predefined and cannot be deleted. Only the Titer can be adapted for those solutions!

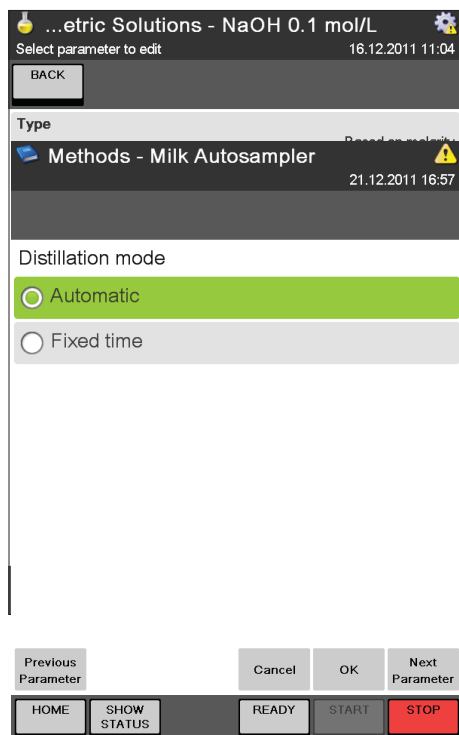

For each solution molarity, valence factor and titer or normality and titer can be specified (for latter one "Type: Based on normality" has to be selected).

6.8.3 Reference Substances



If a reference substance and its theoretical value is defined, it is possible to automatically calculate the recovery rate. Limits for this recovery (lower and upper limit) can also be defined in a way that the system rejects results if they are outside of these limits.

NOTE

Recommended reference substances are ammonium dihydrogen phosphate, glycine, acetanilide, and tryptophan. For information on reference substances, see table in chapter 4.8 Reference substances.

In the following the steps necessary for defining reference substances are described.

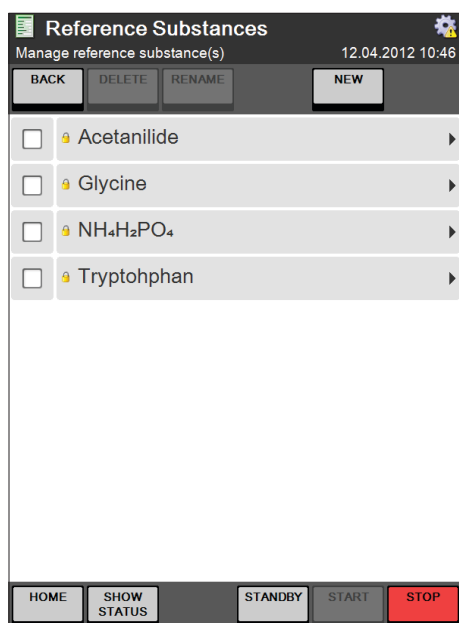

Create a new reference substance with a unique name, or delete or rename an existing one.

NOTE

Reference substances marked with a small padlock are predefined and cannot be deleted or changed!

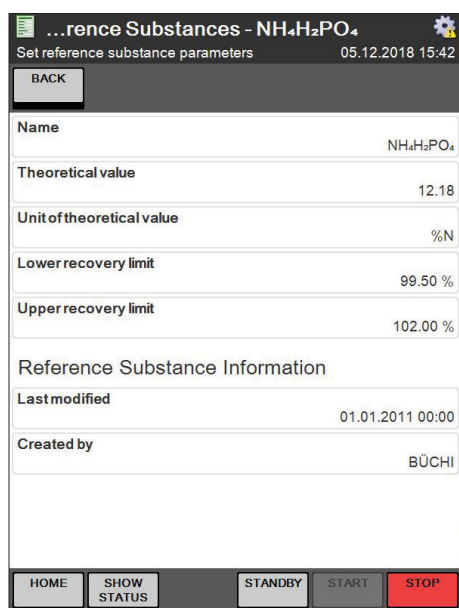

For each reference substance, a theoretical value, related to the nitrogen content can be specified. The unit of this value can be defined freely.

NOTE

Additional units can be defined under Settings ► Units of results (See chapter „6.9.1 Settings“) and afterwards selected from within the Reference Substances dialog.

6.9 Device

The Device area provides access to all tasks that are related to the device itself, like









- adapting the system settings,
- performing system diagnostics,
- using utilities, like database backup, and the lab timer
- Login/Logout to the instrument
- printing all relevant instrument settings

6.9.1 Settings



Overview

The following table provides an overview over all device settings that can be adapted within the settings screen.

Icon	Dialog window	Description
	Regional settings	Adapt Language , Keyboard layout , and Time and Date format .
	Date and time	Set system Date , Time , and Time zone .
	Display and sound	Adapt Display and Sound settings.
	Result units	Select or define the Result units .
	Dosage volume in status view	Define the increments for direct dosing in the status view for H₂O , NaOH , and H₃BO₃ .
	Peripherals	Configure the present Peripherals like Level sensors , Sampler , Balance , and Printer .
	Network	Adapt the Network settings.
	Import and export	Set path for Data Import and export (USB or network) .
	User administration	Create users and assign user rights .
	Device information	View device information like hard- and software versions.
	Service information	Set and reset a service interval , view service information.



Regional Settings

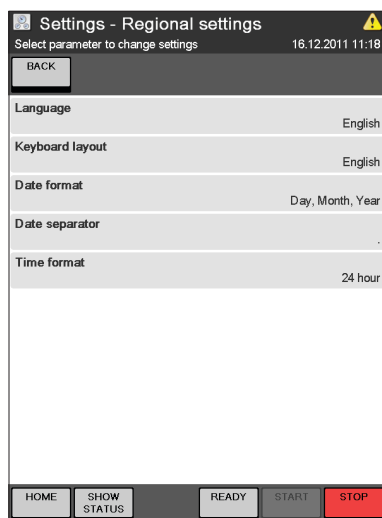

Select your language from the offered range of 7 available languages: English, German, French, Spanish, Italian, Chinese and Japanese.

Switch to your preferred keyboard layout, English, German or French.

The Date format can be switched to “Month, Day, Year”, “Day, Month, Year”, or “Year, Month, Day”, with a slash, dot or hyphen as separator.

The time can be displayed either in 12 hour, or in 24 hour format.



Date and Time



Set Date and Time and select your Time zone.



Display and sound

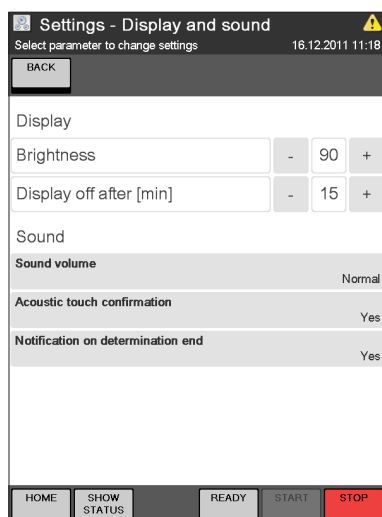

Adapt the brightness of the display and set the switch off time (screen saver).

Set the sound volume and select if there should be an acoustic signal for touch confirmation or for the end of determination notification.



Result units

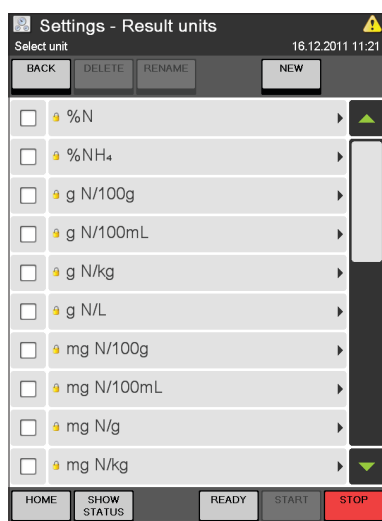

Create a new unit with **NEW** and store it under a new, unique name.

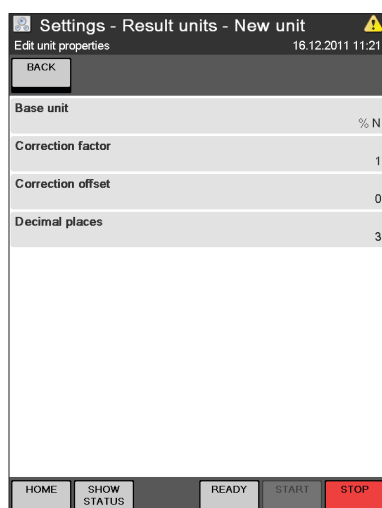

Select a base unit for the new unit calculation
Selectable are: **g N/L**, **% N**, **g Pr/L** or **% Pr**
(N = nitrogen content, Pr = protein content)

Enter a correction factor and/or correction offset if necessary and select the preferred number of decimal places.

(The results are calculated following the linear equation $y = a \cdot x + b$ where **a** is given by the correction factor and **b** by the correction offset.)



Dosage volume in status view

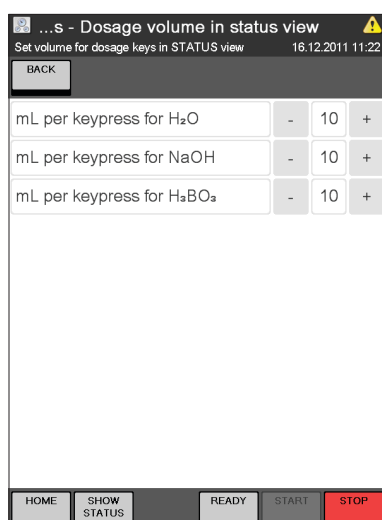

Set the increment in **[mL/click]** for the direct dosing of H₂O, NaOH and H₃BO₃ within the status view. (Per click on the corresponding dose button, the specified amount in mL will be dosed.)



Peripherals

Select **Yes** for all present peripherals:

- Level sensor for receiver waste container
- Level sensor for sample tube waste container
- Sampler
- Balance
- Chiller
- Printer

NOTE

Unlike the level sensors for the storage tanks of H_2O , $NaOH$ and H_3BO_3 , the level sensors for the waste containers have to be activated!
If a chiller is connected to the K-375 it is strictly necessary to select "Yes" for "Chiller used" in order to have the cooling water valve permanently opened.

If a sampler is connected to the instrument, select the type (1 tray for K-376, 2 trays for the K-377) and enable or disable the auto cleaning functionality of the sampler after each sample measurement.

If a balance is connected to the instrument, specify the communication settings for the balance.

- the Baud rate
- the number of Data bits (7 or 8)
- the Parity (none, even or odd)
- the number of Stop bits (1, 1.5 or 2)

NOTE

For details about the single parameters, please refer to the operation manual of the balance.

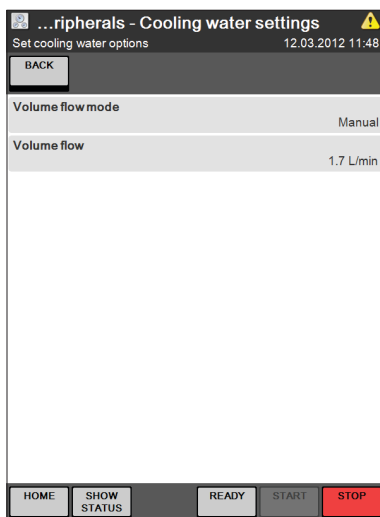

If a chiller is connected to the device the cooling water control will be omitted.

If no chiller is connected the cooling water control can be set either to manual, with a specific flow rate, or to automatic. In automatic mode the temperature of the cooling water is measured and the volume flow is adjusted depending on the water temperature.

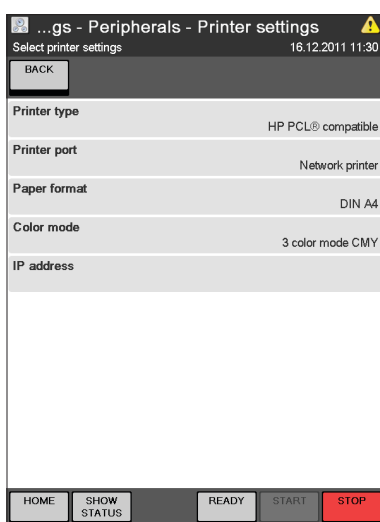

If a printer is connected to the device (HP PCL®-compatible) select the printer port (network or USB-printer), the paper format and the color mode (monochrome, CMY or CMYK).

For a network printer in addition the IP address has to be specified.

NOTE

If no printer is available, you may select Adobe® PDF as printer type – the data is then stored as a pdf-file on a USB stick.



Network

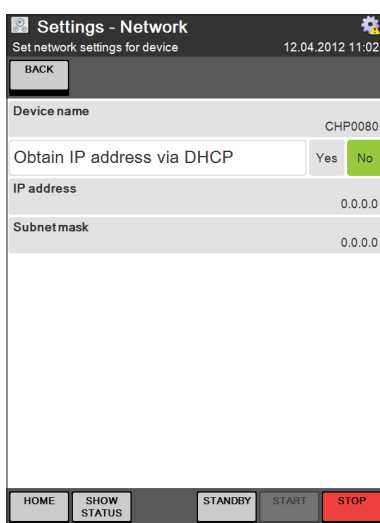

If connected to a network, you can assign a device name for the device to be recognized within the network.

The IP address can either be obtained automatically via DHCP (Select **YES**), or entered manually together with the subnet mask.

NOTE

More details regarding the network connection can be found in the document “Manual – Network connection K-375”, which can be obtained from any authorized BUCHI representative.



Import and export

Specify the target for the manual or automatic data storage. You may either select a USB device or a network directory or both in parallel:

- Select **Yes** for „Use USB device“ for the data storage to a USB device.
- Select **Yes** for „Use network data share“ for data storage on a network place.
- For an automatic data export after each sample determination select **Yes** for „Export results automatically“.

With „Test Export“ the validity of the settings can be checked.

NOTE

For the network settings configuration the help of an IT specialist of the company may be required!

Results are exported from the K-375 using xml-format. Most LIM systems are able to handle this format. If more details regarding the data format are required refer to the document “Manual – Data export K-375”, which can be obtained from any authorized BUCHI representative.



User administration

Create, delete or rename users. Assign user rights to each user.

NOTE

The first created user has to be of type “Administrator”. After different users have been configured, the “User management” is active and the Logout functionality becomes visible on the home screen.

As soon as a user account has been created the system automatically creates a default “BUCHI Administrator” account. This account can be used in case all users with own accounts forgot their passwords. The password for this default administrator account (a four digit code which changes on a daily base) can be obtained from any authorized BUCHI representative.

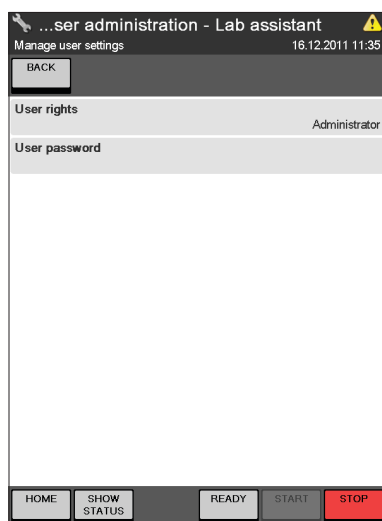

Three levels of user authorisation can be assigned:

- **Administrator** (not restricted)
- **Operator** (limited permissions)
- **Lab Manager** (limited permissions)

See also section „6.3 User concept“.

Device information

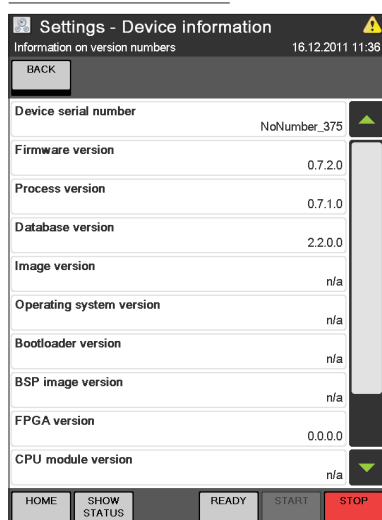

Information about the hard- and software of the system can be viewed.

No Settings can be changed.

Service information

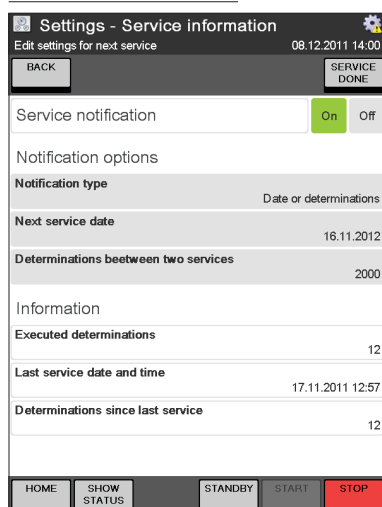

Select **On** for “Service notification“, if messages shall be displayed indicating the necessity of an equipment service. The criteria (next service date, number of performed determinations between two services, or both) can be determined under „Notification options“ within the same dialog. If a specified criterion is fulfilled, a notification message is displayed on the Info display of the Status view (See also section „6.5 The Status view“). If both criteria are selected, the notification is displayed depending on the criteria fulfilled first.

(The total number of determinations, the last service date and the number of performed determinations since the last service are displayed for information reasons.)

6.9.2 Utilities

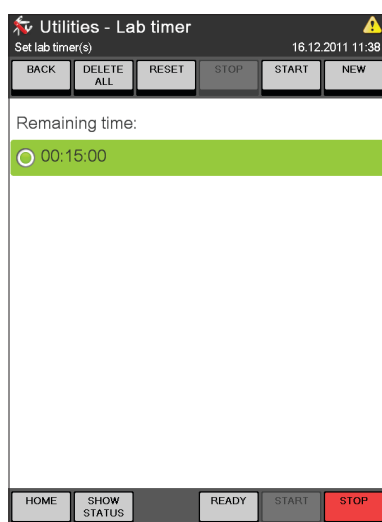
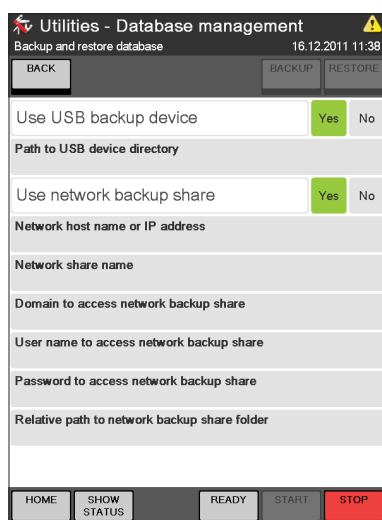
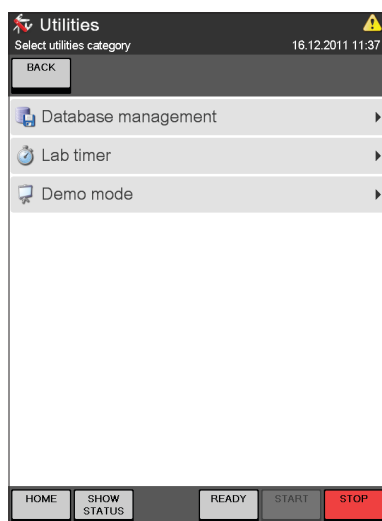

There are three different utilities contained in the device software:

- The **Database management** – backup and restore of the complete device data (settings, methods, resources, results etc.)
- The **Lab timer** – create a countdown timer with acoustic alarm.
- The **Demo mode** – use the device in demo mode (without chemicals).

Database management

The database backup can be stored on a USB device or on a network directory or on both in parallel.

- Select **YES** for a „Use USB backup device“ and/or **YES** for a „Use network backup share“
- Specify the path to the USB and/or network directory.

For the network share the IP address, name, domain and User name and password have to be specified.

NOTE

For the network settings configuration the help of an IT specialist of the company may be required!

Lab timer

- Create or delete a timer and define the countdown time.
- **Start** or **Stop** the selected timer.

NOTE

*After the countdown time has elapsed, an acoustic alarm is triggered. To stop this alarm sound press the upper **STOP** button (Do not press the red STOP button – this will stop all device processes!). The volume of the alarm can be adapted within the „Display and sound“ settings. (See chapter “6.9.1 Settings”)*

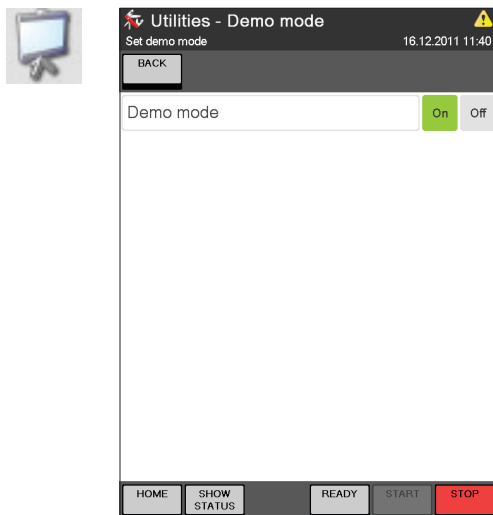

Demo mode

Select **On** to switch to the Demo mode and **Off** to leave the Demo mode.

NOTE

In demo mode no chemicals are used or dosed and determinations are only simulated. The demo mode is automatically deactivated as soon as the instrument is switched off.

6.9.3 Diagnostics

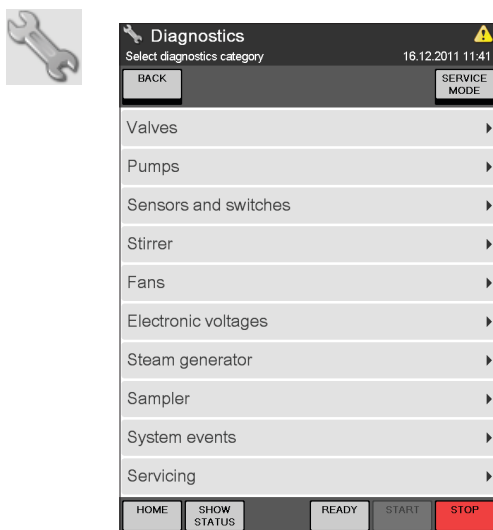

In the system diagnostics the actual status of all system components like valves, pumps, sensors and switches or fans can be checked.

Each item is displayed in a list and, if currently active, a green dot is displayed in front of it.

With the button **SERVICE MODE** one can switch to the service mode to actively set each system component into operation and check it for proper functioning.

NOTE

The diagnostics dialogs are only accessible for user with administrator rights! (For users with operator rights the diagnostics area is "read-only").

CAUTION

While the service mode is activated, some security-relevant functions are stopped. Executing single test functions is therefore subject to the operator's responsibility. The service mode will be switched off, as soon as the diagnostics menu is left.

6.9.4 Logout

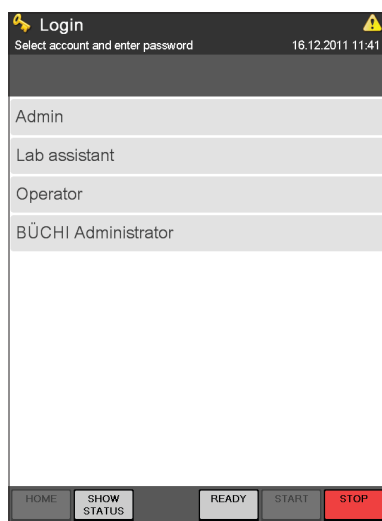

When clicking on **Logout**, the current user is automatically logged out and the Login screen is displayed.

To login to the system, click on one of the present users and – if a password has been specified for this user – enter the corresponding password.



NOTE

Each user with operator rights is allowed to change his own password under the setting „User administration“ (See chapter “6.9.1 Settings“).

7 Maintenance

This chapter gives instructions on all maintenance work to be performed in order to keep the device in good working condition.

	<p>Warning</p> <p>Death or serious injuries by contact with high voltage.</p> <ul style="list-style-type: none"> • All maintenance and repair work requiring the opening or removal of device covers may only be carried out by trained personnel and with the tools provided for this purpose. • Prior to all maintenance work on the device switch off the power supply and remove all sources of flammable vapor. • Only open the housing of the product while the device is switched off and unplugged. Let the device cool down for at least 30 minutes after switching off. • The device may not be reconnected to the power supply before the housing has been closed properly!
	<p>DANGER</p> <p>Risk of chemical burns by corrosives or of intoxication by harmful chemicals.</p> <ul style="list-style-type: none"> • Always wear personal protective equipment such as protective eye goggles, protective clothing and gloves when maintaining the instrument.

	CAUTION
	Risk of burns by hot surface. <ul style="list-style-type: none"> · Always let the device cool down after operation before performing any maintenance work.
	CAUTION
	Risk of burns by hot surface. The steam generator heats up during operation. <ul style="list-style-type: none"> · Always let the device cool down after operation before opening the service door.

All instructions aimed at maintaining the KjellMaster Systems (K-375 / K-376 or K-375 / K-377) respectively the KjellMaster K-375 (standalone) in good working condition are to be observed. This also includes periodic cleaning and checking for any possible damage.

After each maintenance process the measurement-technical reliability according to EN ISO 8655, Part 3 and 6 has to be verified.

If a disturbance, a malfunction or another defect becomes obvious, the maintenance work must be carried out immediately.

7.1 Daily maintenance

7.1.1 Before sample determination (potentiometry)

- Remove the electrode from the storage cap (the cap can be fixed to the electrode holder on the front side of the housing) and place it into the receiving vessel.
- Rinse the titration hoses (Path: System Preparation ▶ Buret functions ▶ Buret function “Dose”).
- Calibrate the pH electrode with fresh buffer solution, see also chapter “6.6.1 System Preparation”.
- Prime the system (Path: System Preparation ▶ Priming), see also chapter “6.6.1 System Preparation”.
- Submerge the pH electrode into the measuring medium at least up to the diaphragm.

NOTE

All glass parts must be warm before the analysis begins. Therefore a preheating of the system is necessary if more than 15 minutes pass between two determinations (Path: System Preparation > Preheating).

Cleaning between samples is not necessary, unless sample deposits are found in the splash protector. (Path: System Preparation ▶ Cleaning).

7.1.2 Before sample determination (colorimetry)

- Set up the receiving vessel as described in Section 5.9.2
- Rinse the titration hoses (Path: System Preparation ▶ Buret functions ▶ Buret function “Dose”).
- Preheat the system (Path: System Preparation ▶ Setpoint colorimetric sensor ▶ Preheating before Setpoint), see also chapter “6.6.1 System Preparation”.
- Perform Setpoint determinations as described in chapter “6.6.1 System Preparation” (Path: System Preparation ▶ Setpoint colorimetric sensor)
- Prime the system (Path: System Preparation ▶ Priming), see also chapter “6.6.1 System Preparation”.
- Submerge the sensor into the measuring medium at least up to the measuring cell.

NOTE

All glass parts must be warm before the analysis begins. Therefore a preheating of the system is necessary if more than 15 minutes pass between two determinations (Path: System Preparation ▶ Preheating). Cleaning between samples is not necessary, unless sample deposits are found in the splash protector. (Path: System Preparation ▶ Cleaning).

7.1.3 After sample determination

Clean the system using the Cleaning procedure and/or manual cleaning.

7.1.3.1 Automatic cleaning procedure

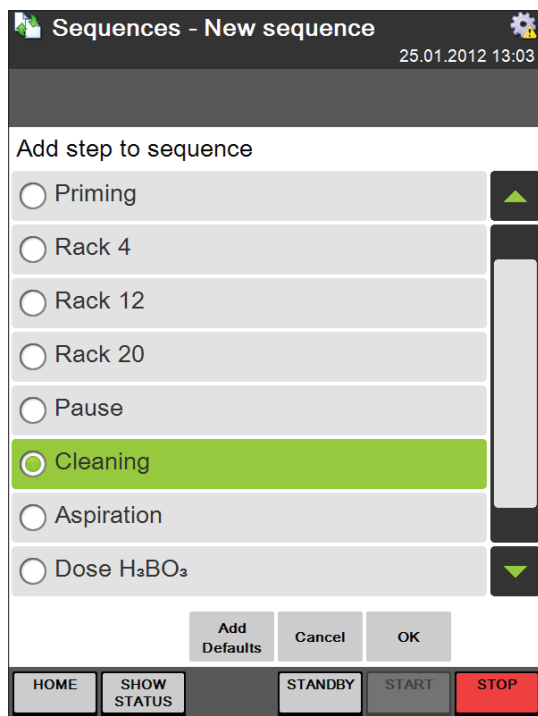

- The software offers the possibility to add a cleaning step to each sequence for the sample determination with a sampler K-376 / K-377. If you choose “Add defaults” when creating a new sequence the cleaning step is automatically added to the sequence subsequent to the rack determination step.
- However, if you do not create a new sequence based on the default steps, the cleaning step can be added to the sequence at any time using the NEW button.

NOTE

Use 150 mL distilled water for cleaning if a 300 mL sample tube is used.

Use 300 mL distilled water if a 500 mL sample tube is used.

Change volume of water in: System Preparation ▶ Cleaning ▶ H₂O volume.

7.1.3.2 Cleaning of the pH electrode

- Rinse off the pH electrode with distilled water, do not wipe it off but carefully sponge off excess droplets.
- Place the pH electrode into the storage cap – the pH electrode must be stored in saturated KCl solution (4.2 mol/L).

7.1.4 pH electrode

Storage

The pH electrode must be stored in saturated KCl solution (4.2 mol/L).

NOTE

A pH electrode should not be stored dry as this would destroy the diaphragm. If a pH electrode has been stored dry, let it regenerate in saturated KCl for 24 hours or at least over night prior to further use. Never touch the tip of the electrode and do not wipe it with tissue paper or cloth.

Calibration

Treat the electrode according to the recommendation described in the electrode supplementary sheet.

Calibrate the electrode every day before starting sample determinations.

We recommend replacing the electrode, if it does not fulfill the following criteria at 25 °C room

temperature anymore:

- Slope 95 – 105 %
- Zero point pH 6.4 – 7.6

For pH electrodes other than the ones supplied by BUCHI, additional criteria might be important.

NOTE

It is recommended to use buffer solutions pH 4.00 and 7.00.

Discard buffer solutions after usage. Work with fresh solutions every day.

...aration - Calibration pH electrode	
Set calibration options for pH electrode 25.01.2012 13:35	
BACK	CHART HISTORY
Calibration type	2-point calibration
Buffer 1 pH	4.00
Buffer 2 pH	7.00
Buffer temperature	25.0 °C
Sensor voltage buffer 1	168.0 mV
Sensor voltage buffer 2	0.0 mV
Slope	100.00 %
Zero point pH	7.00
Calibration	OK
Slope lower limit	95.00 %
HOME	SHOW STATUS
READY	START STOP

To calibrate the pH electrode

- select System Preparation ► Calibration pH electrode
- adapt all parameters to your needs
- press **START** and follow the SOP given by the software.

Details about all available parameters can be found in chapter “6.6.1 System preparation”.

7.1.5 Filling boric acid into receiving vessel after last sample of rack was determined (potentiometry only)

By default the pH electrode has to be stored in saturated KCl solution. Keeping the electrode for a long time in air reduces its lifetime.

If there is no chance to clean the electrode and store it in KCl solution, we recommend to fill boric acid into the titration vessel after the last sample was determined.

Boric acid can be dosed into the receiver at the end of each sequence:

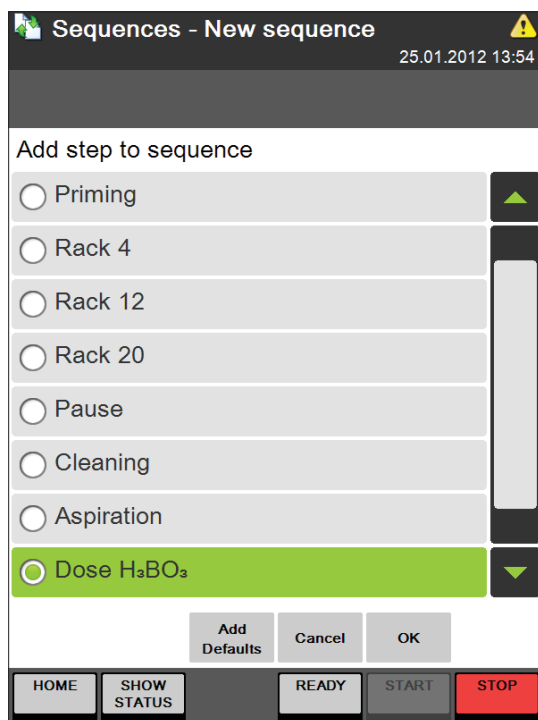

- If you choose “Add defaults” when creating a new sequence the dosing step is automatically added to the sequence.
- However, if you do not create a new sequence based on the default steps, the dosing step can be added to the sequence at any time using the NEW button.
- To dose boric acid manually, use the dosing button provided in the status view (refer to “6.5 The status view”).

7.1.6 Sample tube cleaning

NOTICE

Risk of sample tube damage.

Sample tubes can break due to mechanical or temperature shocks.

1. *Do not cool down sample tubes with cold water.*

2. *Do not place hot sample tubes and the rack on a cold surface.*

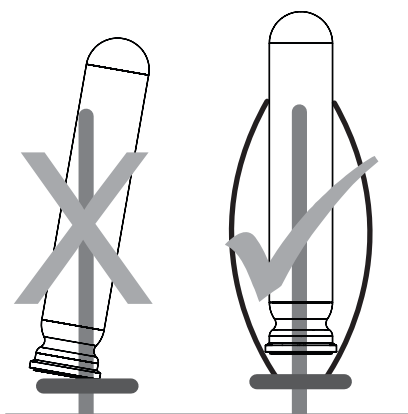

Fig. 7.1: Cleaning single tubes

Single tube

- Place the sample tube into the dishwasher to prevent any damage.
- Make sure the sample tubes are properly mounted in the dishwasher to prevent any damage.

NOTE

Sample tubes with scratches or chips can break during a process.

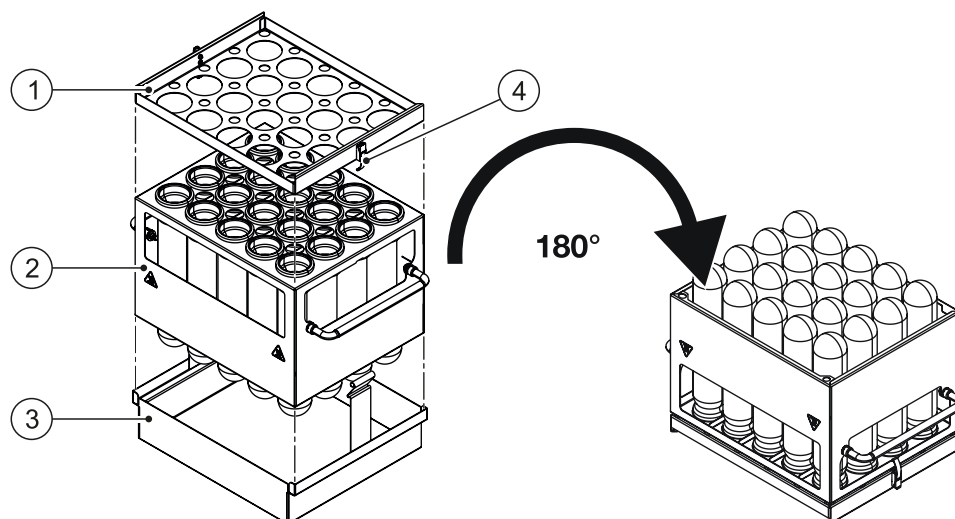

Fig. 7.2: Cleaning tubes in the rack

NOTE

To clean the tubes and rack together in the dishwasher additional accessories are required.

- Place the sample tubes and rack (2) on the rack stand (3).
- Install the retaining plate (1) and lock it with the 2 latches (4) to secure the sample tubes.
- Turn the rack upside down and place it in the dishwasher.

7.2 Weekly maintenance

7.2.1 Cleaning the housing

The housing is made of polyurethane.

You can clean it with water inside and outside. The use of organic solvents (except ethanol) can lead to damage and is not recommended. Acid splashes are tolerated by the housing for short periods, but must be immediately removed with water in order to avoid stains.

7.2.2 Cleaning the titrator

- Clean the housing of the titration unit with a moist piece of cloth with normal household cleaning agents.
- Treat the bottom and rear side dry. In no case must liquid penetrate into the interior of the titration unit.

7.2.3 Cleaning the glass parts of the dosing unit

Please refer to the manual for the dosing unit for cleaning instructions. After cleaning and complete drying, visually examine every part for chipped areas and cracks.

7.2.4 Cleaning the dip tube of the KjelSampler

Remove the dip tube carefully and clean it using normal household cleaning agents. Afterwards rinse it with distilled water. The sampler head and seal can be cleaned with a moist piece of cloth.

NOTE

To remove the dip tube, first remove the rack from the sampler tray and move the arm to the service position: System Preparation ► Sampler functions ► Move to service position. Use "Move to zero position" after reattaching the dip tube.

7.2.5 Device monitoring

In order to test/check the instrument, a nitrogen determination with a reference substance can be carried out. We recommend the following parameters as standard application.

Parameters for checking the distillation and titration procedure with ammonium dihydrogen phosphate:

Check:	Distillation and titration
*Reference substance:	Ammonium dihydrogen phosphate min 99.5 %
Nitrogen content:	w =0.1212 (12.12 %)
Original sample weight:	200 mg
Receiving solvent:	Boric acid 4 %, adjusted to pH 4.65 (with NaOH)
Titration solution:	0.2 N (HCl or H ₂ SO ₄)
Determination method:	Standard
Number of blank values:	≥ 3
Acceptable RSD blanks:	≤ 5 %
Number of samples:	≥ 3
Acceptable recovery rate reference substance:	99.5 ... 102 %
Acceptable RSD:	1 %

* this is only a guideline; please verify and use your specific purity of the reference substance. Therefore check the respective "Certificate of Analysis" which is delivered from the manufacturer of the reference substance and create a modified reference substance according to it.

Parameters for checking the digestion, distillation and titration with glycine.

Check:	Digestion, distillation and titration
Reference substance:	Glycine (99.7 %)
Drying before analyzing:	8 h at 105 °C
Nitrogen content:	w =0.1866 (18.66 %)
Original sample weight:	200 mg
Kjeldahl catalyst:	Titanium BUCHI Kjeldahl Tablets
Catalyst amount:	2 tablets
Sulfuric acid conc. 98 %:	15 mL
Digestion temperature:	see BUCHI Application Notes
Digestion time:	see BUCHI Application Notes
Receiving solvent:	Boric acid 4 %, set to pH 4.65 (with NaOH)
Titration solution:	0.2 N (HCl or H ₂ SO ₄)
Determination method:	Standard
Number of blank values:	≥ 3
Acceptable RSD blanks:	≤ 5 %
Number of samples:	≥ 3
Acceptable recovery rate reference substance:	98.0 ... 102 %
Acceptable RSD:	1 %

7.2.6 Cleaning colorimetric sensor and mesh

- Rinse the sensor and the protection mesh thoroughly with distilled water
- Use only soft tissues to wipe the mirror surface and make sure no foreign material is on it, as this would involve the danger of the surface getting scratched
- Exchange the mesh when it is deformed

7.3 Monthly maintenance

7.3.1 Calibrating the pump

It is recommended to calibrate the pumps with the same volume as used for the methods. To perform the calibration a graduated cylinder is needed.

Example H₂O pump

...m Preparation - Pump calibration	
Set pump calibration options 26.01.2012 11:21	
BACK	
Pump	H ₂ O
Dose volume	50 mL
Calibration volume	50 mL
HOME SHOW STATUS STANDBY START STOP	

Path: System Preparation ► Pump Calibration

- Select H₂O for “Pump”
- Enter the quantity to be dosed (e. g. 50 mL) for the parameter “Dose volume”. (The last measured volume is always shown under “Calibration volume”)
- Press **Start** to start dosing H₂O.

...m Preparation - Pump calibration
26.01.2012 11:21

Calibration volume [mL]

51

7 8 9 mL
4 5 6
1 2 3
0

Previous Parameter Cancel OK Next Parameter
HOME SHOW STATUS STANDBY START STOP

- Transfer the dosed volume into a graduated cylinder, measure the volume and enter the measured volume in the “Calibration volume [mL]” screen.

...m Preparation - Pump calibration
Set pump calibration options 26.01.2012 11:20

BACK

Pump	H ₂ O
Dose volume	50 mL
Calibration volume	51 mL

HOME SHOW STATUS STANDBY START STOP

The value shown for “Calibration volume” is updated.

NOTE

Repeat this procedure until the entered and the dosed volume correspond. An acceptable difference at 50 mL is ± 5 mL.

H₂O and NaOH can be dosed into the sample tube and then poured into a graduated cylinder for measurement.

The H₃BO₃ can be dosed directly into the receiving vessel and then poured into a graduated cylinder.

7.3.2 Checking the distillate amount

- Carry out preheating (three times) so that the system is warm before performing this test.
- Create a new method using the following parameters:

H ₂ O volume:	0 mL
NaOH volume:	0 mL
Reaction time:	0 s
Distillation mode:	Fixed time
Distillation time:	300 s
Stirrer speed distillation:	5
Steam output:	100 %
Titration type:	None
Aspiration sample tube:	Yes
Aspiration receiving vessel:	No

- Run the method with an empty sample tube and empty receiving vessel.
- Measure the distilled quantity in the receiving vessel using a graduated cylinder.

NOTE

The distillate amount with above parameters must be ≥ 130 mL.

7.3.3 Inspecting the buret

Inspect the attached buret(s) to recognize damages as early as possible.
Carrying out a test according to EN ISO 8655, Part 3 and 6.

7.3.4 Inspecting the titrator

Inspect the electrical contacts (plugs, stirrer) for corrosion and mechanical damage, if the titration unit is used in premises with an occasional occurrence of corrosive matters in the atmosphere.
Control the hoses, the threaded connections and the seals for visible damage, contamination and leakage.

If there is suspicion that a solution is attacking the glass excessively, the maintenance interval must be reduced accordingly.

7.3.5 Inspecting the sample tubes

Sample tubes are subject to wear and tear, especially due to the impact of NaOH and also caused by cleaning in a dish washer. To avoid leaks during distillations it is recommended to check each tube with the supplied test gauge and to sort out the ones not passing all criteria. Follow the instructions given on the test gauge and perform all five tests.

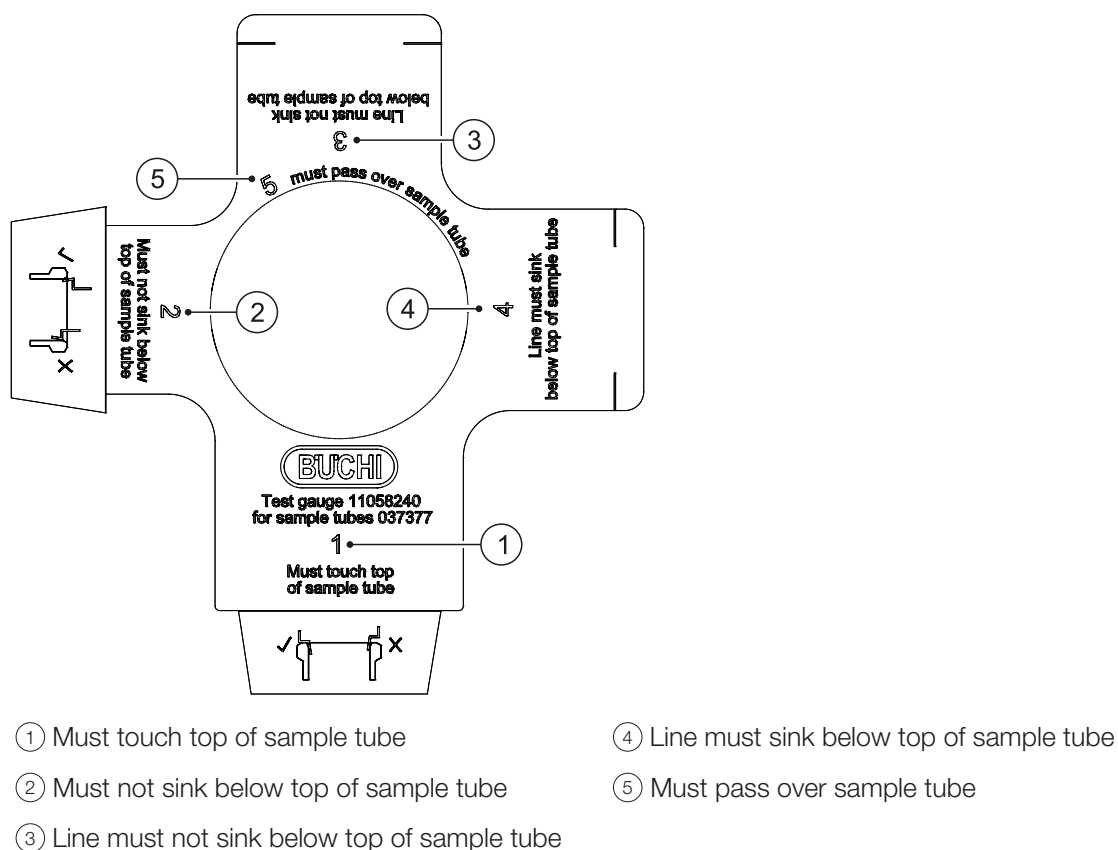

Fig. 7.1 Test gauge for sample tubes

NOTE

New sample tubes should be checked for the first time after being used for three months. Afterwards they should be checked on a monthly base.

Check all glass parts for scratches ① or chips ②:

NOTE

Sample tubes with scratches or chips can break during determinations:

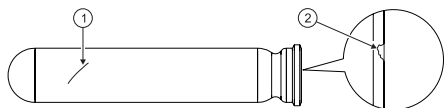

Results

Glass parts show no damage:

The glass parts are O.K.

Glass parts have scratches ① or chips ②.

Replace faulty glass parts.

7.4 Half-yearly maintenance

7.4.1 K-375 Sealing between sample tube and splash protector

We recommend to replace the rubber sealing on the splash protector (connection to the sample tube) every half year to avoid leakages.

	NOTICE
	<p>Risk of device damage by overtightening the screw fitting.</p> <ul style="list-style-type: none"> · The screw cap shall only be tightened hand-tight.

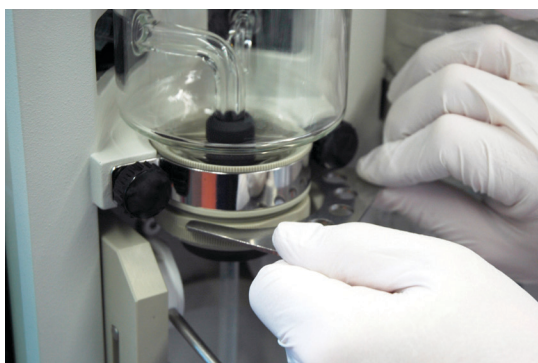

- Use the open end spanner (11058252) contained in the standard delivery of the device to loosen the screw cap holding the sealing.

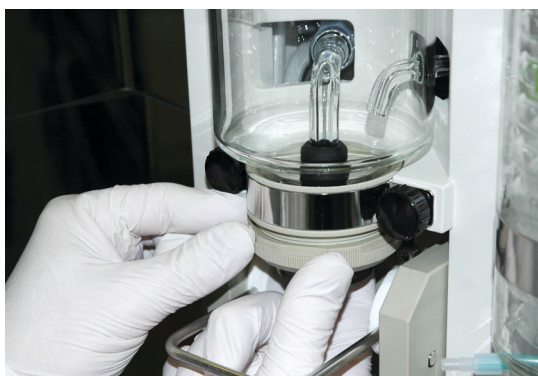

- Unscrew the screw cap by hand.

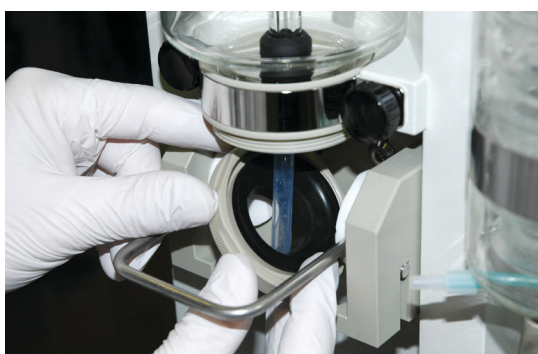

- Carefully take the screw cap with the sealing away from the device and replace the sealing along with the inner fixation ring.
- Reassemble in reversed order.

NOTE

Depending on sample throughput and instrument care it may be necessary to exchange this seal more often. At least after around 1500 distillations an exchange should be considered.

7.4.2 K-376 / K-377 dip tube and sealing cap

The sealing cap is an expendable part which needs to be replaced periodically. We recommend to replace this **every half year** according to the below instruction. During use the dip tube will change its color from white to grey. This is caused by the steam and should not have an impact on the results. Nevertheless we recommend to replace it every half year together with the sealing cap.

	<p>CAUTION</p>
	<p>Risk of burns by hot surface.</p> <ul style="list-style-type: none"> Always let the device cool down after operation before touching the dip tube, the sealing or the transfer and steam hoses.

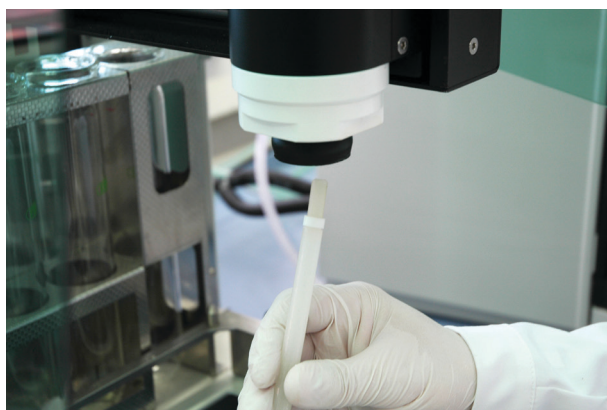

- Take the sample rack away from the tray
- Move the sampler arm to the service position. (System Preparation ► Sampler functions ► Move to service position)
- The dip tube can be pulled out of the sampler arm from below.

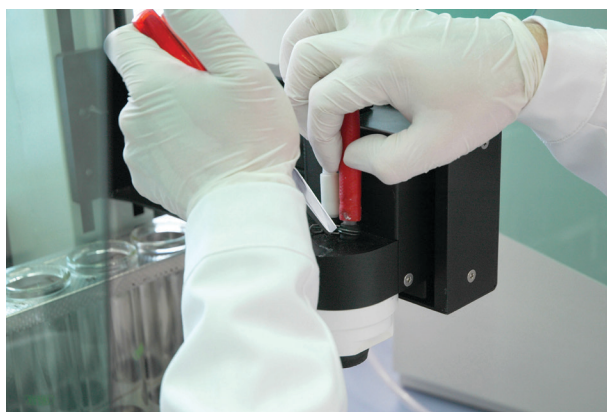

- To replace the sealing cap, first remove the two hose clamps from the red steam hose and the white transfer hose using a flat nose plier.



- Remove both hoses from the two fittings of the sealing cap.

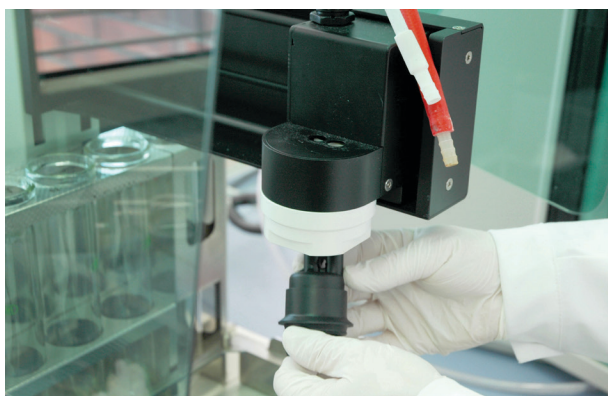

- Pull the sealing cap out of the sampler arm from below.
- When inserting the new sealing cap from below take care to its orientation – the two fittings on top are not arranged symmetrically. When the sealing cap is inserted properly, both fittings have to reach through the two corresponding holes in the sampler arm.
- The red hose belongs to the fitting with the red marking, the white hose to the one with the white marking.
- Retain the sealing cap from below while reattaching the two hoses to prevent it from slipping out again.
- Push a new dip tube as far as it will go into the sealing cap from below.
- Move the sampler arm to the zero position. (System Preparation ► Sampler functions ► Move to zero position)
- Reinstall the sample rack.



NOTE

Depending on sample throughput and instrument care, an exchange of the sealing cap should be considered after around 2000 distillations. If steam leaks, the sealing cap needs to be exchanged immediately.

7.4.3 Replacing the splash protector

Replace the glass splash protector after approximately 3000 distillations, at the latest after 5000 distillations. The plastic splash protector needs to be replaced after around 8000 distillations.

For the replacement of the splash protector the open end spanner (11058252) and the tool SVL 22 (11057779) are needed. Both are part of the standard delivery.

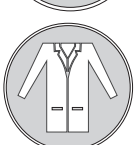
   	<p>! WARNING</p> <p>Serious chemical burns by corrosives.</p> <ul style="list-style-type: none"> • Observe all data sheets of the used chemicals. • Handle corrosives in well ventilated environments only. • Always wear protective goggles. • Always wear protective gloves. • Always wear protective clothes. • Do not use damaged glassware.
---	---

**! WARNING**

Death or serious injuries by contact with high voltage.

- Make sure device is switched off and unplugged before replacing the pump.

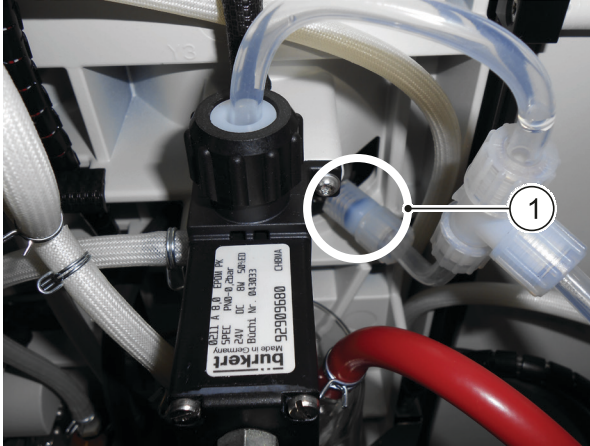

Open the service door.

- Disconnect the water connection ①.
- Disconnect the NaOH connection ②.

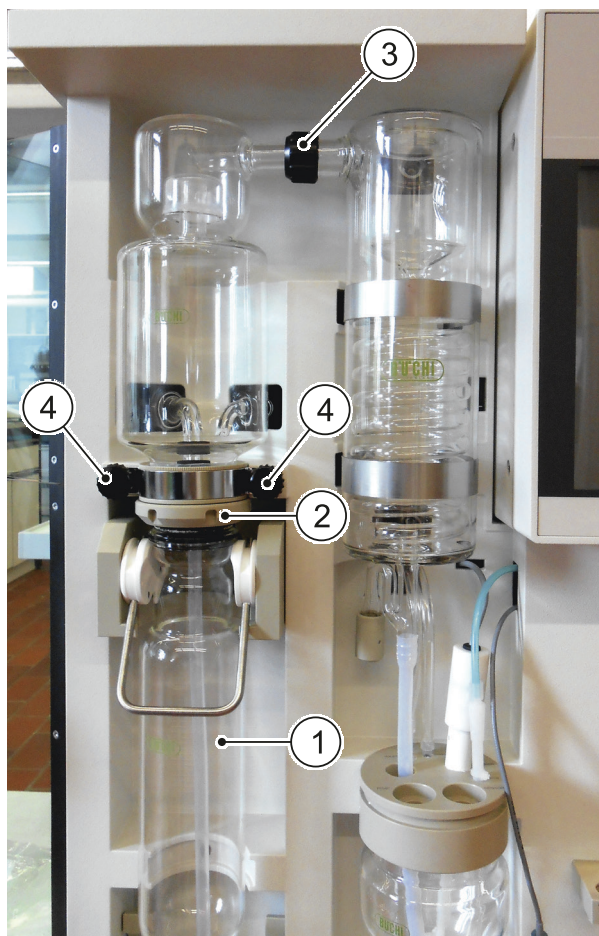

- Remove the sample tube and the dip tube ①.
- Remove the screw cap with the sealing as described in section 7.4.1 ②.
- Loosen the screw cap with the open end spanner (11058252) and slide it back ③.
- Loosen the two screws ④ and take the holder away.
- Take the Splash protector away from the instrument and replace it with a new one.
- Reassemble in reverse order.

7.5 Yearly maintenance

7.5.1 Replacement of wear parts

Replace the following components:

- Seals including the sealing cap of the sampler and the splash protector seal.
- NaOH pump and boric acid pump (the other pumps as required).
- Dip tube.
- pH electrode (if required depending on sample throughput and maintenance of the pH electrode).
- Wave spring in the sampler arm.
- Hoses inside the distillation unit, especially the ones that make contact with steam, NaOH and H₃BO₃.

7.5.2 Decalcification of the steam generator



To decalcify the steam generator proceed as follows:

- Make sure that the steam generator is cooled down (switch off the unit and let it cool down for at least 30 minutes)
- Remove the water of the steam generator (see 9.1 Emptying the steam generator)
- Mix about 0.8 L of solution for decalcification (use approx. 160 g citric acid or 80 g amidosulfuric acid dissolved in 0.8 L water)
- Remove the hose from the H₂O pump on the back of the device and connect another hose with the pump
- Dip this hose into the decalcification solution
- Switch on the K-375
- After initialization the pump starts running
- Switch off the unit after the steam generator is filled with the solution (pump stops running)
- Let the solution dissolve the lime for 0.5 – 1 hour
- Remove the solution of the steam generator (see step 1 and 2)
- Perform a second decalcification (see step 5 – 10)
- Connect the hose from the water tank with the pump for H₂O
- Flush the steam generator 2 – 3 times with distilled water (see step 6 – 8 and 10)
- Perform 2 – 3 times a CLEANING (cleaning procedure) of the instrument

7.5.3 Replacement of the sodium hydroxide pump

The pump for sodium hydroxide is considered as an expendable part which needs to be replaced once per year as a proactive measure.

Proceed as follows:

	<p>! WARNING</p> <p>Serious chemical burns by corrosives.</p> <ul style="list-style-type: none"> • Observe all data sheets of the used chemicals. • Handle corrosives in well ventilated environments only. • Always wear protective goggles. • Always wear protective gloves. • Always wear protective clothes. • Do not use damaged glassware.
	<p>! WARNING</p> <p>Death or serious injuries by contact with high voltage.</p> <ul style="list-style-type: none"> • Make sure device is switched off and unplugged before replacing the pump.

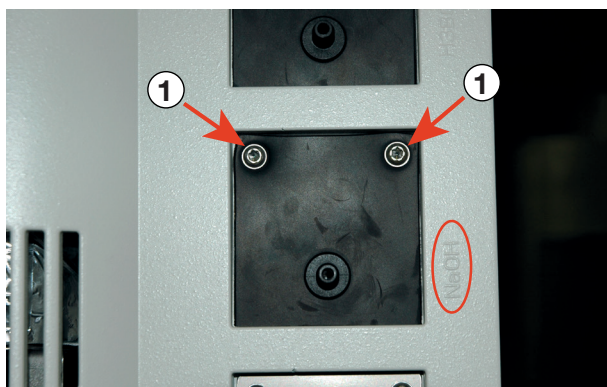

- Remove the two screws a on the rear side of the instrument. The position of the sodium hydroxide pump is marked on the housing with the imprinting "NaOH".

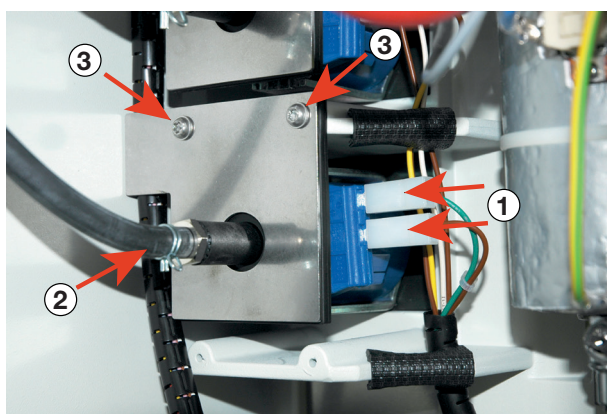

- Open the service door.
- The sodium hydroxide pump is the lowermost of the three pumps situated on the left side.
- Disconnect the two plug connectors ①. (Note for reassembly: The upper one connects the green cable, the lower one the brown cable!)
- Disconnect the tube on the front side ②.
- Unscrew the two screws ③ from the front panel and take the front panel away. The pump becomes loose now and can be replaced.
- Reassemble in reversed order.

7.5.3 Replacement of the wave spring

- Remove the rack and move the sampler arm to the service position.
- Remove the dip tube.
- Pull the wave spring together with the wave spring holder out of the sampler arm from below:

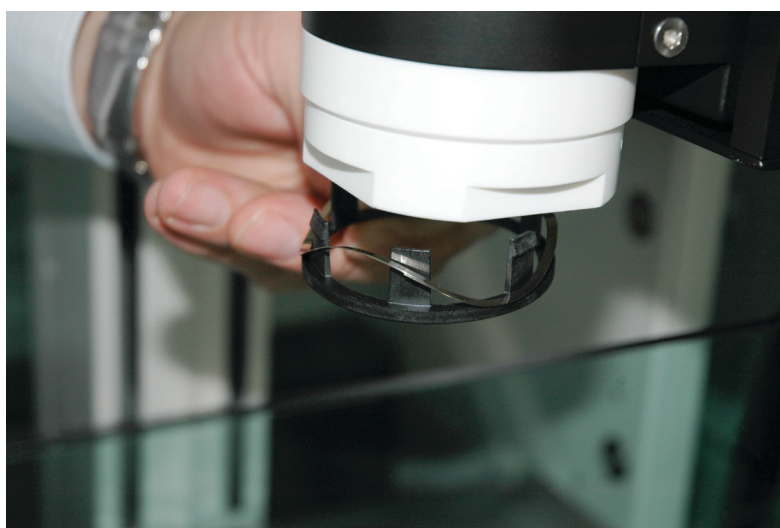

- Plug a new wave spring with a new holder from below into the sampler arm:





**NOTE**

Make sure that one of the clips of the holder presses on the spring inside the sampler arm. (See arrow in the figure beneath.)

Otherwise the sample tube detection will not work!

7.6 Replace every two years

7.6.1 Replacement of the transfer connection

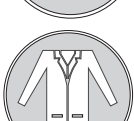
	<p>! WARNING</p> <p>Serious chemical burns by corrosives. Risk of burns by hot steam.</p> <ul style="list-style-type: none"> · Never operate the K-375 together with a sampler while the sample transfer and/or steam hose is getting porous or cracked.
   	<p>! WARNING</p> <p>Serious chemical burns by corrosives.</p> <ul style="list-style-type: none"> · Always wear protective goggles. · Always wear protective gloves. · Always wear protective clothes.

The transfer connection consisting of the transfer hose, the steam hose and the black protective sleeve shall be replaced at least every two years or if required.

To replace the transfer connection proceed as follows:

- Switch both devices (the KjelMaster and the KjelSampler) off.
- Wait until all parts of the devices have cooled down to room temperature.
- Loosen the connections of the transfer hose and the steam hose on the rear side of the K-375 (see chapter 5.3.2 for details).
- Loosen the protective sleeve and the connections for the steam hose and the transfer hose on the sampler arm of the KjelSampler (see chapter 5.3.1 for details).
- Take the transfer connection away from the devices and replace it with a new one.

7.7 Maintenance work if required

7.7.1 Changing the buret tip

The buret tip consists of the shaft (4) with threaded clamping (2) and slip-on tip (5). The buret tip is inserted into the receiver vessel using the distance holder (3).

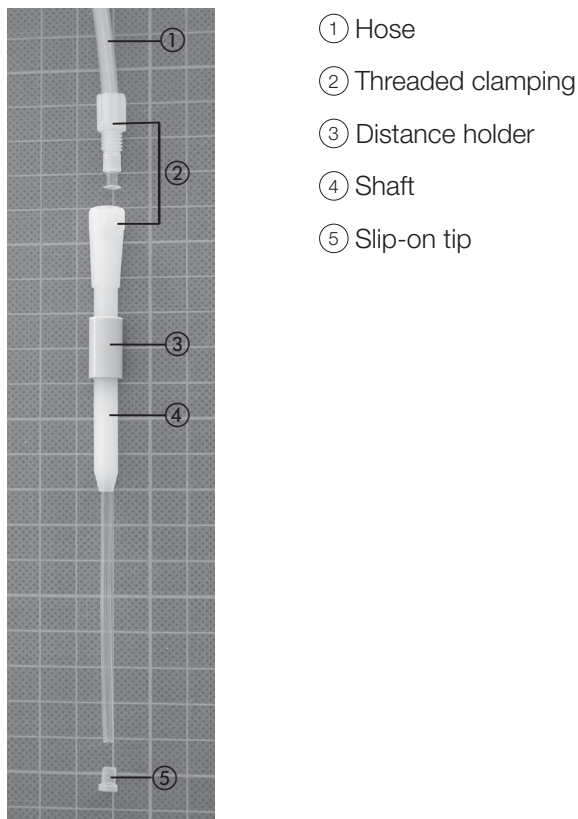

Fig. 7.2: Disassembling and assembling a buret tip

To assemble the buret tip, proceed as follows:

- Screw the shaft (4) to the hose (1).
- Slip the distance holder (3) onto the shaft.
- Push the slip-on tip (5) onto the end of the shaft.

7.7.2 Cleaning the pH electrode

If the glass membrane or diaphragm are dirty, clean them to maintain the measuring function. Depending on the degree of contamination, submerge only the glass membrane or the glass membrane with the diaphragm into the cleaning solution.

Depending on the degree of contamination, the methods mentioned below are recommended. After cleaning, rinse off the electrode with distilled water, condition it in electrolyte solution for 1 hour or longer and recalibrate it prior to any further measurements.

Soiling	Treatment	Comments
---------	-----------	----------

Inorganic substances	Several minutes, e. g. with HCl 0.1 mol/L or NaOH 0.1 mol/L	Improved cleaning action with warm solutions (40–50 °C)
Organic substances (oil, grease, etc.)	Rinse off with a suitable organic solvent (e.g. ethanol) or tenside solution	For plastic shaft electrodes, take chemical resistance into account. Sensor can also be wiped off with a soft, moistened cloth.
Proteins	Approx. 1 hour with pepsin/HCl solution	5 % pepsin in 0.1 mol/L HCl
Sulfides (on ceramic diaphragm)	With thiourea/HCl solution (6.5 % in HCl 0.1 mol/L) up to discoloration	Cause: Reaction of electrolyte with measuring solution.

Table 7-1: Cleaning methods of the pH electrode

7.7.3 Replacing the buret

As a rule, the need for replacing the buret occurs only rarely. It has to be replaced only as a result of a defect.

7.7.4 Cleaning the splash protector and the rubber seal

In case the splash protector or the rubber seal is contaminated and this contamination was not removed during the daily maintenance work, proceed as follows:

- Dismount the splash protector and remove the rubber seal.
- Rinse the splash protector with water to remove sample residues.

We recommend to replace the glass splash protector after approximately 3000 – 5000 determinations, depending on the kind of application and frequency of maintenance. The plastic splash protector can last more than 8000 distillations.

To prolong the lifetime of the seal, rinse it with water, especially if working with crystalline products. Afterwards, dry it with a soft cloth, remount it and put the splash protector back in place.

	NOTICE
	<p>Risk of device damage.</p> <ul style="list-style-type: none"> · When removing and reinstalling the seal, make sure not to damage it. · Always move it perpendicularly to the axis of the glass parts and ensure no damage occurs to the sealing lip. · Never apply grease to the seal and never touch it with sharp objects, otherwise it will get damaged.

7.7.5 Glass parts

Replace the sample tubes and the condenser if broken (see chapter 7.3.5). In case a KjelSampler K-376 / K-377 is used, the 500 mL tube, used for all distillations, should be replaced whenever a new splash protector is mounted to the K-375.

7.7.6 Troubleshooting the dosing unit

If the dosing unit is blocked, this may be caused by the valve disc and the distributor disc adhering to one another. In this case cleaning of both discs may solve the problem.

For the disassembly of the dosing unit refer to chapter “3.7 Disassembling the dosing unit” in the manual of the dosing unit which is supplied together with the K-375.

Cleaning of the valve disc and the distributor disc is described in chapter “4.1.2 Cleaning valve disc and distributor disc”, remedying the adherence of both is explained in chapter “4.1.3 Discs adhere to one another”.

7.7.7 Adjusting the sample tube holder

In case the K-375 does not detect the sample tube, displaying the error message “10102 No sample tube present” or if leaks are observed, the sample tube holder needs to be adjusted.

To adjust the sample tube holder, the adjustment gauge 11059802 is needed:

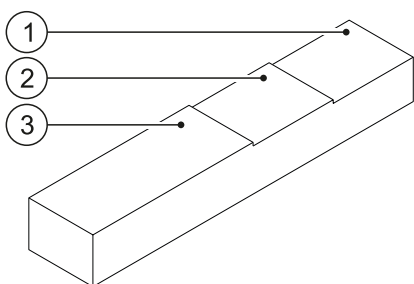
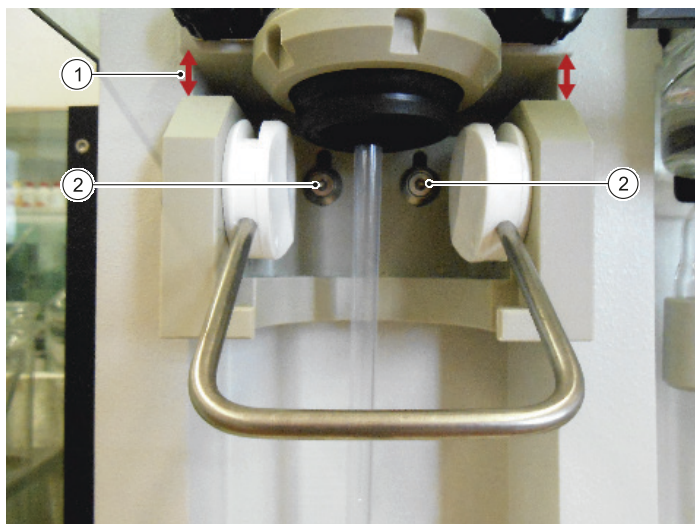

Fig. 7.3 Gauge 11059802 for adjustment of the sample tube holder

- ① Step 1 for older, worn splash protector seals ③ Step 3 for new splash protector seals
- ② Step 2 for little used splash protector seals



To adjust the distance between the sample tube holder and the splash protector seals ① for an optimum contact pressure,

- slightly loosen the two screws ②

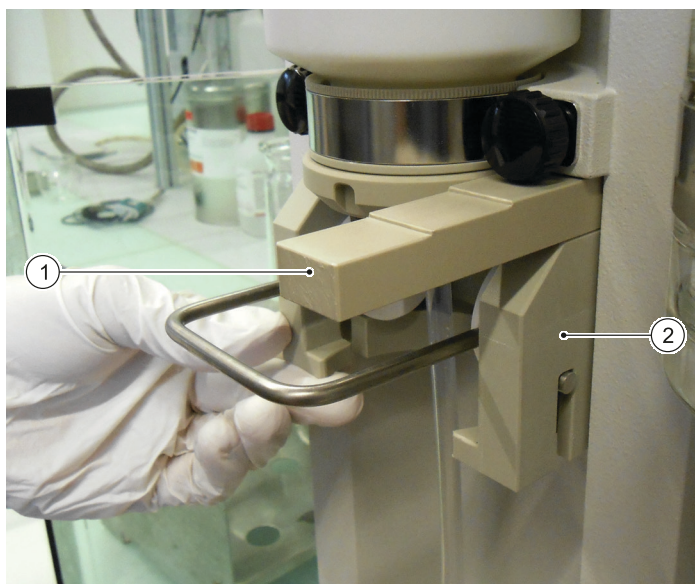

Fig. 7.4 Adjustment of the sample tube holder

- insert the gauge ► into the gap between the holder and the housing (insert the gauge according to the condition of the seal – for a new seal insert the thick end of the gauge, for a worn sealing use the thin end, or the middle part)
- move the sample tube holder ② upwards against the gauge ① and tighten the two screws on the holder
- remove the gauge ①
- insert a sample tube and test the connection of the sample tube for tightness
- if necessary repeat the adjustment using another step of the gauge

NOTE

If the adjustment of the sample tube holder does not remedy the problem, it may be necessary to exchange the sample tube holder and/or the splash protector seal.

7.8 Customer service

Only authorised service personnel are allowed to perform repair work on the instrument. These persons have a comprehensive technical training and knowledge of possible dangers which might arise from the instrument.

Addresses of official BUCHI customer service offices are given on the BUCHI website under: www.buchi.com. If malfunctions occur on your device or you have technical questions or application problems, contact one of these offices.

The customer service offers the following:

- Spare part service
- Installation Qualification (IQ)
- Operation Qualification (OQ)/Repeating OQ
- Repair service
- Maintenance service
- Technical advice
- Application support

8 Troubleshooting

This chapter helps to resume operation after a minor problem has occurred with the instrument. It lists possible occurrences, their probable cause and suggests how to remedy the problem.

The troubleshooting table below lists possible malfunctions and errors of the instrument. The operator is enabled to correct some of those problems or errors by him/herself. For this, appropriate corrective measures are listed in the column "Corrective measure".

The elimination of more complicated malfunctions or errors is usually performed by a BUCHI technical engineer who has access to the official service manuals. In this case, please refer to your local BUCHI customer service agent.

8.1 Problems that may occur

It is not possible to start a determination

- The steam generator is in stand-by mode. Activate the steam generator by pushing the "Ready" button.

No sample transfer from K-376 / K-377 to K-375

- Check the system for leakages (K-376 / K-377, K-375 and transfer tubes/connections)
- Check the position of the dip tube on the K-376 / K-377: distance between sample tube bottom and dip tube must be about 2 mm. If necessary, adjust the dip tube accordingly
- Check the system by means of a Priming. If this does not help, check the glass tubes in the K-376 for cracks and tube height.

Crystallized samples

- Dissolve the crystallized sample by warming it up. Otherwise sample transfer is not possible.

Typical mistakes digestion

Crystallization after digestion

- False ratio of H₂SO₄ to catalyst
- Digestion time too long
- Suction capacity of scrubber too strong
- Leakage in the suction system

Samples do not get clear

- No or too little catalyst used
- Digestion temperature too low
- Temperature too high – sealing material was flushed into the sample

Fume leakage

- Seals are defective
- Suction capacity of scrubber too weak
- Leakage in the system, e.g. hose connector not tight
- Blocked hoses
- Reduced suction on the bypass valve

Boiling retardation/bumping/foaming

- Missing digestion rods or boiling stones are used
- Missing Antifoam tablet or other anti-foaming agent

Typical mistakes distillation

Samples do not get dark blue/brown after addition of NaOH

- Empty NaOH tank
- Air in NaOH hose
- No catalyst used for digestion (only H₂O₂)

Splashing during distillation or addition of chemicals

- Chosen wrong sample tubes
- Volume in sample tubes too high
- Not enough water used for dilution

Other problems that may occur

Problem	Cause	Corrective measure
Nitrogen content too high	· Air in titration system, buret, tubes	· Refill buret
	· Carry over during distillation	· Use less volume, or increase water volume for dilution
	· Wrong titrant	· Use right concentration
	· Error in calculation	· Check calculation and concentration of titration, molar reaction factor, factor of titrant
	· Defective pH electrode	· Calibrate electrode, replace if necessary
	· Defective colorimetric sensor	· Clean the sensor surface, place the sensor in cleaning solution during idle periods
	· Dirty glassware	· Only use clean glassware
	· Air bubbles disturb the colorimetric titration	· Check the top fitting on the condensate inlet

Problem	Cause	Corrective measure
Nitrogen content too low	· Incomplete digestion	· Increase digestion time
	· Insufficient H ₂ SO ₄	· Increase volume
	· Kjeldahl Tablets and H ₂ SO ₄ in wrong ratio	· Correct ratio
	· Nitrogen content per sample tube is too high	· Not more than 200 mg Nitrogen per sample tube
	· Not enough NaOH or incorrect concentration of NaOH used (required is 32 %)	· Correct volume until color change is visible
	· Leakage during distillation	· Check and tighten, check connection between condenser and splash protector, replace seal if required
	· Leakage during digestion	· Check sealing and scrubber suction capacity
	· Wrong titrant used	· Check and correct
	· Defective pH electrode	· Calibrate electrode, replace if necessary
	· Defective colorimetric sensor	· Clean the sensor surface, place the sensor in cleaning solution during idle periods
	· Dirty glassware	· Only use clean glassware
	· Air bubbles disturb the colorimetric titration	· Check the top fitting on the condensate inlet

Problem	Cause	Corrective measure
Poor repeatability	<ul style="list-style-type: none"> · Air bubbles in titration system, buret, tubes · Aspiration not working properly · pH electrode incorrectly calibrated or not calibrated (only in the case of potentiometric determination) · Setpoint determination out of the specific range (only for colorimetric determination) · Sample inhomogeneous · Sample weighing problems · Incomplete digestion, digestion time too short · Suction capacity during digestion is too strong · Stirrer is not working · Dip tube blocked, loose, too short or defective · Air bubbles disturb the colorimetric titration · Incorrect positioning of the titration dosing tip · Indicator aging · Incorrect ratio of indicator to boric acid, or incompatible indicator used · Loose contact of the sensor cables 	<ul style="list-style-type: none"> · Fix tubing and refill buret · Check for leaks and fix · Calibrate electrode with fresh buffer · Perform Setpoint determination · Homogenize sample · Use weighing boats to improve procedure · Check color of samples during digestion and choose digestion time accordingly · Reduce suction power at the Scrubber with the bypass valve · Clean the stirrer, replace if necessary · Check and collect dip tube · Clean the sensor surface, place the sensor in cleaning solution during idle periods · Check and correct position · Exchange boric acid with indicator by fresh solutions · Check and correct according to the BUCHI application notes · Check cables and correct

8.2 Error messages on the display of the K-375

The error messages consist of an error number and a short text explaining the problem.

If the problem can't be solved by the operator – please write down the error number and contact the BUCHI service for further assistance.

Message ID	Description	Remedy
10'001	Aborted by user	Restart process
10'002	Distillation starting point not found.	Check the electrode and try again
10'003	Last shutdown failed. Please make sure the device is switched off by pushing the power switch.	Use the power switch to turn off the instrument
10'004	Method without aspiration. Aspiration required with sampler.	Activate the aspiration
10'005	Demo mode is activated.	Use Demo mode or switch to operating mode
10'011	Real time clock battery is low. Date and time have been reset. Please set correct date and time in settings. Change of battery is recommended.	Exchange the battery
10'101	Door is open	Close the door
10'102	No sample tube present	Attach sample tube or adjust sample tube holder
10'103	Tube shield open	Close tube shield
10'104	Preheating recommended	Perform preheating
10'105	Cleaning recommended	Perform cleaning
10'110	Buret disconnected	Connect buret
10'121	H ₂ O tank empty	Fill up water
10'122	NaOH tank empty	Fill up sodium hydroxide
10'123	H ₃ BO ₃ tank empty	Fill up boric acid
10'124	Waste receiver tank full	Empty tank
10'125	Waste sample tube tank full	Empty tank
10'126	Acid tank empty	Fill up acid
10'200	Sensor 'pump current' out of order	Fault in current detection, AD-converter or other hardware component. Call service.
10'204	Sensor 'cooling water flow' out of order	Fault in cooling water flow measurement, AD-converter or other hardware component. Call service.

10'208	Sensor 'steam pressure' out of order	Fault in steam pressure measurement, AD-converter or other hardware component. Call service.
10'217	Analog digital converter out of order	Fault in AD-converter or other hardware component. Call service.
10'300	No cooling water flow detected. Please turn on water tap.	Check cooling water supply. Turn on tap or chiller.
10'301	Aspiration error: No vacuum detected	Check the system for leaks
10'302	Cooling water flow too low	Assure higher flow rate or check parameters in Settings/Peripherals/Cooling water settings
10'303	Low pressure during distilling	System pressure is below 150 mbar. Check for leaks or call service.
10'311	Pump H ₂ O has no current	Faulty water pump. Exchange pump or call service.
10'312	Pump NaOH has no current	Faulty NaOH pump. Exchange pump or call service.
10'314	Pump H ₃ BO ₃ has no current	Faulty boric acid pump. Exchange pump or call service.
12'001	Valve steam (Y1) out of order	Faulty valve or wire harness. Call service.
12'002	Valve cooling water in (Y5) out of order	Faulty valve or wire harness. Call service.
12'003	Valve sampler steam (Y6) out of order	Faulty valve or wire harness. Call service.
12'004	Valve sampler transfer (Y7) out of order	Faulty valve or wire harness. Call service.
12'005	Valve 5 (not used) out of order	Faulty valve or wire harness. Call service.
12'006	Valve waste sample tube (Y2) out of order	Faulty valve or wire harness. Call service.
12'007	Valve aspiration in (Y3) out of order	Faulty valve or wire harness. Call service.
12'008	Valve receiver (Y4) out of order	Faulty valve or wire harness. Call service.
12'009	Valve H ₂ O injection (Y8) out of order	Faulty valve or wire harness. Call service.
12'010	Valve H ₂ O sample tube (Y9) out of order	Faulty valve or wire harness. Call service.
12'011	Valve waste receiver (Y10) out of order	Faulty valve or wire harness. Call service.
13'001	27V power supply overcurrent	Faulty electronic board. Call service.
13'002	Ventilator power overcurrent	Fan short circuit. Call service.
13'003	Ventilator electronics blocked	Check for blockage or call service
13'004	Ventilator interior blocked	Check for blockage or call service

14'001	Titrator not ready	Check if all cables are plugged to the titrator, restart the system or call service.
14'002	Titrator information	Call service
14'003	Titrator not started	Titrator error. Check function in System Preparation/Buret function. Call service.
14'004	Titrator not started, pH value too low	pH value is below the set endpoint. Verify the electrode, dosing unit and boric acid.
14'005	Titrator not started, pH value too high	pH value is above the set endpoint. Verify the electrode, dosing unit and receiving solution.
14'006	Wrong titration direction	Ensure pH electrode is immersed in receiving solution and verify if the right titration solution is used.
14'007	Titration speed over specification	Overtitration. Use lower concentrated titration solution or reduce titration speed.
14'008	Titration speed over specification	Overtitration during back titration. Use lower concentrated titration solution or reduce titration speed.
14'010	Titrator module could not create service 11	Distillation unit needs to be switched off and on
14'011	Titrator module could not create service 21	Distillation unit needs to be switched off and on
14'012	Titrator module could not create service 41	Distillation unit needs to be switched off and on
14'013	Titrator module could not create service 3	Distillation unit needs to be switched off and on
14'100	Titrator timeout	Titration endpoint not reached. Check dosing unit, if enough titration solution is available or update firmware.
14'101	Titrator measured value is out of range	Verify the buffers used for calibration, check the sensor.
14'501	Dosing unit not ready, please check	Verify if the dosing unit is connected to the distillation unit.
14'502	Dosing unit locked	Check the dosing unit and switch distillation unit off and on.
14'503	Dosing unit not ready, no exchange unit	Check if dosing unit is connected to the distillation unit
14'504	Dosing unit not ready, no dosino	Check if dosing unit is connected to the distillation unit
14'505	Dosing unit overload	Call service
14'506	Dosing unit not ready, cock blocked	Dismantle the dosing unit (see chapter "Troubleshooting the dosing unit")

14'602	Titrator stopped, maximal volume reached	Make sure the electrode is in good working conditions, the correct titration solution is used and that no air bubbles are in titrator hoses.
14'603	Titrator stopped, stop endpoint reached	Check the titrator and if enough titration solution is available
14'604	Titrator stopped, stop Potential reached	Check the titrator and if enough titration solution is available
14'605	Titrator stopped, stop time reached	Check the titrator and if enough titration solution is available
15'001	No sampler connected	Switch on sampler and check the connection cable
15'002	Sampler: Target not achieved	Try again or call service
15'003	Sampler: Connection lost	Check the connection cable
15'101	Sampler: Shield open	Close shield
15'102	Sampler: Crash detected	Try again or call service
15'103	Sampler: Tube not found	Put sample tube in place or call service
15'104	Sampler: Tube not released	Remove sample tube or call service
15'105	Sampler: Error 5, reserve (does not exist)	Call service
15'106	Sampler: Error 6, reserve (does not exist)	Call service
15'107	Sampler: Shield not locked	Call service
15'108	Sampler: Error reference position	Call service
15'109	Sampler zeroadjustment not possible because x or y deviation is larger than 3mm or sampler was not in reference position before adjustment start	Try again or call service
15'110	Sampler: Position error X-axis	Call service
15'111	Sampler: Position error Y-axis	Call service
15'112	Sampler: Position error Z-axis down	Call service
15'113	Sampler: Position error Z-axis up	Call service
15'114	Sampler: Error during EEPROM writing. Adjustment value not saved	Call service
17'001	Steam generator overtemperature	Switch distillation unit off and on or call service
17'002	Water level not reached	Check steam generator water supply or call service
18'001	Stirrer out of order	Check stirrer cable or exchange stirrer

50'001	Device powered on	System message, no error.
50'002	Device powered off	System message, no error.
50'003	User login	System message, no error.
50'004	User logout	System message, no error.
50'006	Device power failure during determination	System message, no error.
50'007	Automatic export error	System message, no error.
50'008	Sequence information	System message, no error.

8.3 Eliminating errors of the KjelSampler K-376 / K-377

Check the function of the KjelSampler K-376 / K-377 (test procedure).

In case you observe any leakage between a sample tube and the sampler arm with the sealing cap, you may check the sample tube with the provided test gauge (see chapter 7.3.5).

In case the sampler arm does not move to the reference position (for determination of the exact position), proceed as follows:

- Close the protective shield.
- Press the toggle switch at the back and hold it until the sampler arm is in the upper end position.

	NOTICE
	<p>Risk of device damage.</p> <ul style="list-style-type: none"> · There is no mechanical end stop for the sampler arm movement. Only keep on pressing the toggle switch until the sampler arm is slightly above the rack, to be able to move the sampler arm.

If an error on the K-376 / K-377 cannot be eliminated, the KjelMaster K-375 can also be operated without the sampler. In this case deactivate the KjelSampler in the Settings menu.

Using the toggle switch on the rear side of the KjelSampler it is possible to move the sampler arm and to perform a long-term test:

Press and hold for more than 2.5 seconds	Moves arm up continuously.
Press 2 times within 2.5 seconds	Move arm to service position.
Press 3 times within 2.5 seconds	Move arm to zero position.
Press 4 times within 2.5 seconds	Move arm to the washing position (for transportation)
Press 5 times within 2.5 seconds	Start long-term test.

NOTE

In case the sampler arm of the K-376 or K-377 can not be moved by reason of an electronic failure, it can be lifted manually using a hand crank. The hand crank can be obtained from any authorized BUCHI representative.

In case you observe any leakage between a sample tube and the sampler arm with the sealing cap, you may check the sample tube with the provided gauge.

8.4 Eliminating errors of the titrator

The buret is not properly filled

Possible reasons	Action/remedy
The reagent bottle is empty.	Replace or refill the reagent bottle.
The hose is not immersed deep enough into the reagent bottle.	Immerse the hose deeper into the bottle, or fill up reagents.
The buret is not properly locked.	Lock the buret.

Air bubbles in the titration system

Possible reasons	Action/remedy
The hose connections are not tight.	Check whether the hose has been pulled out of the threaded connection and screw it on manually. Replace the hoses including the threaded connections. Refill the buret

Titration solution is not titrated/dosed

Possible reasons	Action/remedy
The buret is not properly filled.	Perform initial filling.
The hose or the titration tip are wrinkled or blocked.	Check for a clear passage through hose and titration tip and replace the corresponding parts, if necessary.
Undissolved parts in the titration solution.	Filter or replace titration solution.

9 Taking out of operation

This chapter instructs how to shut down the instrument, how to pack it for storage or transport, and specifies the storage and shipping conditions.

Before the device is shipped,

- the mains cable,
- all level sensors,
- the cable to the dosing unit,
- the hoses to the sampler (if used)

must be disconnected and

all water/reagent hoses must be disconnected and removed from the tanks. The hoses and pumps for boric acid and sodium hydroxide dosage must be rinsed thoroughly with distilled water.

9.1 Emptying the steam generator

To empty the steam generator, proceed as follows:

- Turn off the instrument.
- Let the steam generator cool down for 30 minutes.

	! CAUTION
	<p>Risk of burns by hot surface. The steam generator heats up during operation.</p> <ul style="list-style-type: none"> · Always let the device cool down after operation before opening the service door.

- Open the service door.
- Attach an appropriate silicone hose a to the drain cock b at the steam generator.
- Insert the silicone hose into a vessel with at least 500 mL volume.
- Slowly open the stop-cock b with a screw driver and completely empty the steam generator.
- Close the stop-cock with a screw driver.

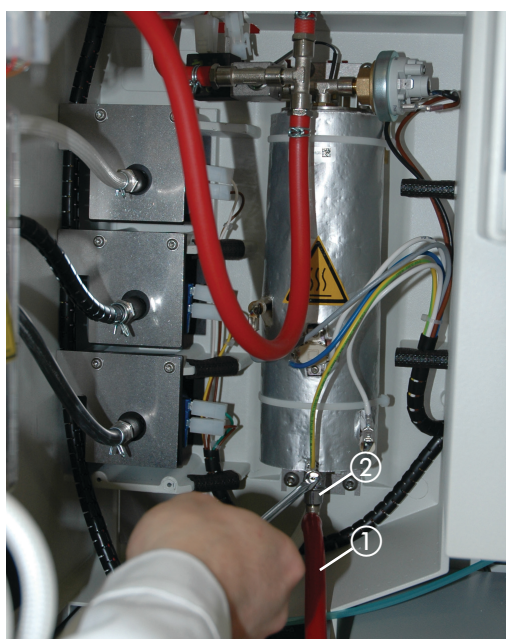



- ① Silicone hose to collection vessel
- ② Drain with stop cock

9.2 Emptying the buret of the titrator

Empty the buret of the titrator before shipping the instrument.

9.3 Storage/shipping

	 CAUTION
	Biohazard. <ul style="list-style-type: none">· Remove all dangerous substances from the device and clean it thoroughly.

Store and transport the device in its original packaging.

NOTE

Move the K-376 sampler arm to the washing position for transport.

9.4 Disposal

To dispose of the device in an environmentally friendly manner, a list of materials is given in chapter 3. This helps to ensure that the components are separated and recycled correctly. Make especially sure to dispose of the gas springs appropriately.

Please follow valid regional and local laws concerning disposal.

10 Spare parts









This chapter lists spare parts, accessories, and options including their ordering information.

Order the spare parts from BUCHI. Always state the product designation and the part number when ordering spare parts.

Use only genuine BUCHI consumables and genuine spare parts for maintenance and repair to assure good system performance and reliability. Any modifications to the spare parts used are only allowed with the prior written permission of the manufacturer

10.1 Spare parts K-375

Product	Order number	Picture
Sample tubes (set of 4) 300 mL	37377	①
Sample tubes (set of 20) 300 mL	11059690	①
Sample tubes (set of 4) graduated 300 mL	43049	②
Sample tubes (set of 4) 100 mL	11057442	③
Sample tubes (set of 4) 500 mL	43982	④
Receiving vessel 340 mL	43333	⑤
Receiving vessel 420 mL	43390	⑥
Receiving vessel, optical sensor	11068263	
O-ring 190.1 x 3.53 EPDM 75	049767	⑦
O-ring 247.2 x 3.53 EPDM	11058241	
Buffer solution pH 4, 250 mL	11064974	⑧
Buffer solution pH 7, 250 mL	11064975	⑨
Indicator according to Sher, 100 mL	03512	⑩
Glass splash protector	043332	⑪
Plastic splash protector	043590	⑫
Devarda splash protector	043335	⑬
Seal (rubber bung) with inner fixation ring	11057035	⑭
Outlet tube for distillate, PTFE	11057361	⑮
Set of tube connectors bent, EPDM sealing (4 pcs)	043129	⑯
Set of clamps Ø 6.6/Ø 10.9/Ø 8.6/ Ø 9.7/Ø 12.8 (5 pcs each)	043586	⑰
Condenser K-375	043320	⑱
Check valve, complete	043356	⑲

Product	Order number	Picture
Set condenser sealing	11058428	
pH electrode (without cable)	11056842	
Electrode cable	11057399	
Stirrer rotor blade	043466	
Stirrer rotor blade, colorimetric titration	11068266	
Stirrer, complete	11056590	
Dosing unit (20 mL)	11056836	
Driving motor for dosing unit	11056835	
Colorimetric sensor with cable	11066601	
Drip tray	11057428	
Seals for cooling water hose (set)	040043	
Hoses for receiver FEP (set)	043191	
Titrator dosing tip	11058745	
Accessory kit for colorimetric sensor	11068260	
Receiving vessel, optical sensor	11068263	

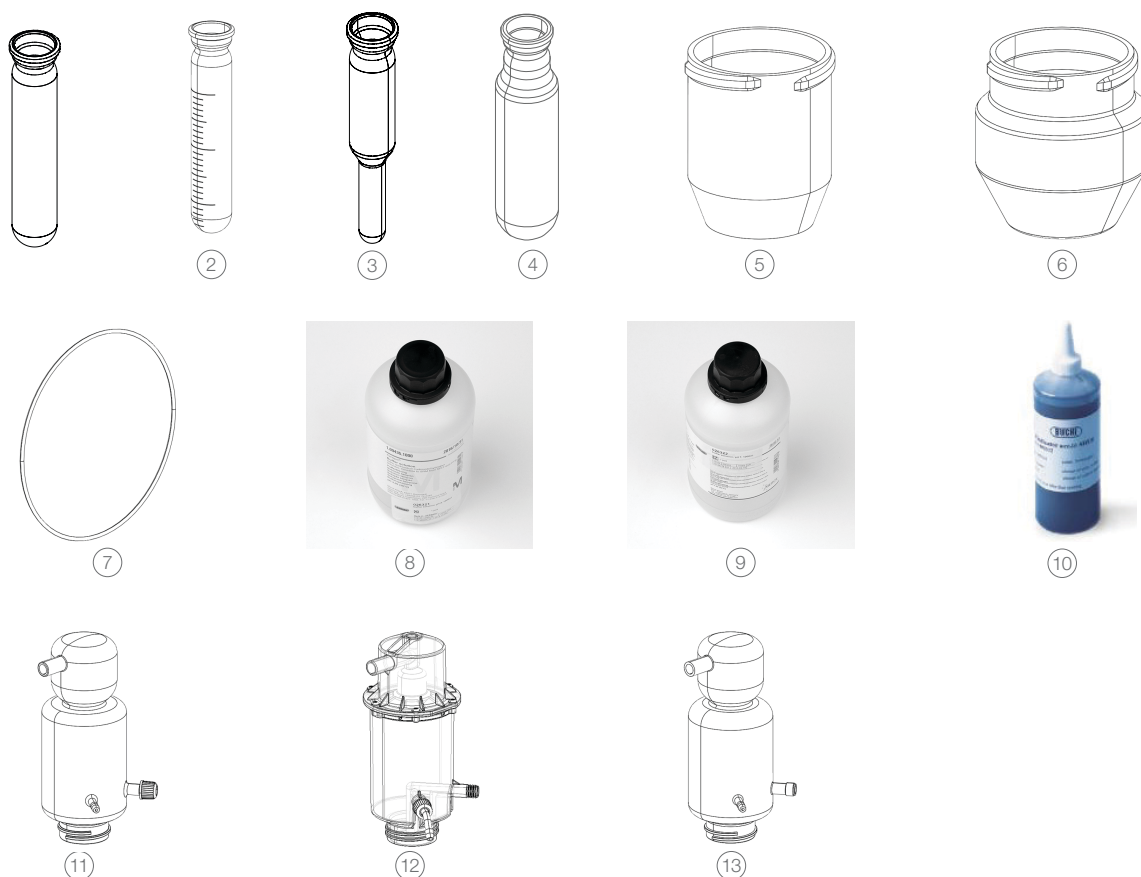

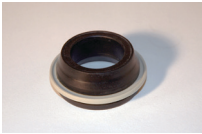

14



15

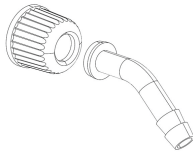

16

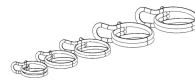

17



18

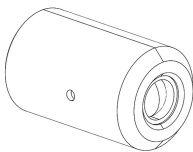

19



20



21

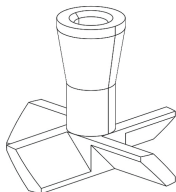

22



23

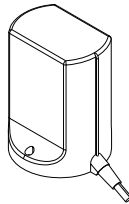

24

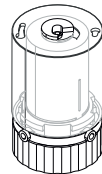

25

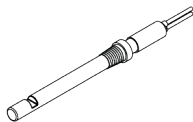

26



27



28

10.2 Spare parts K-376 / K-377

Product	Order number	Picture
Transfer unit, complete		
for K-376	11059035	①
for K-377	11059036	②
Dip tube	11056031	
Dip tube with cross-slot	00047845	
Drip tray K-376 / K-377	00043827	
Sealing cap	11057284	③



10.3 Hosing connection scheme Kjeldahl Sampler System K-375 / K-376

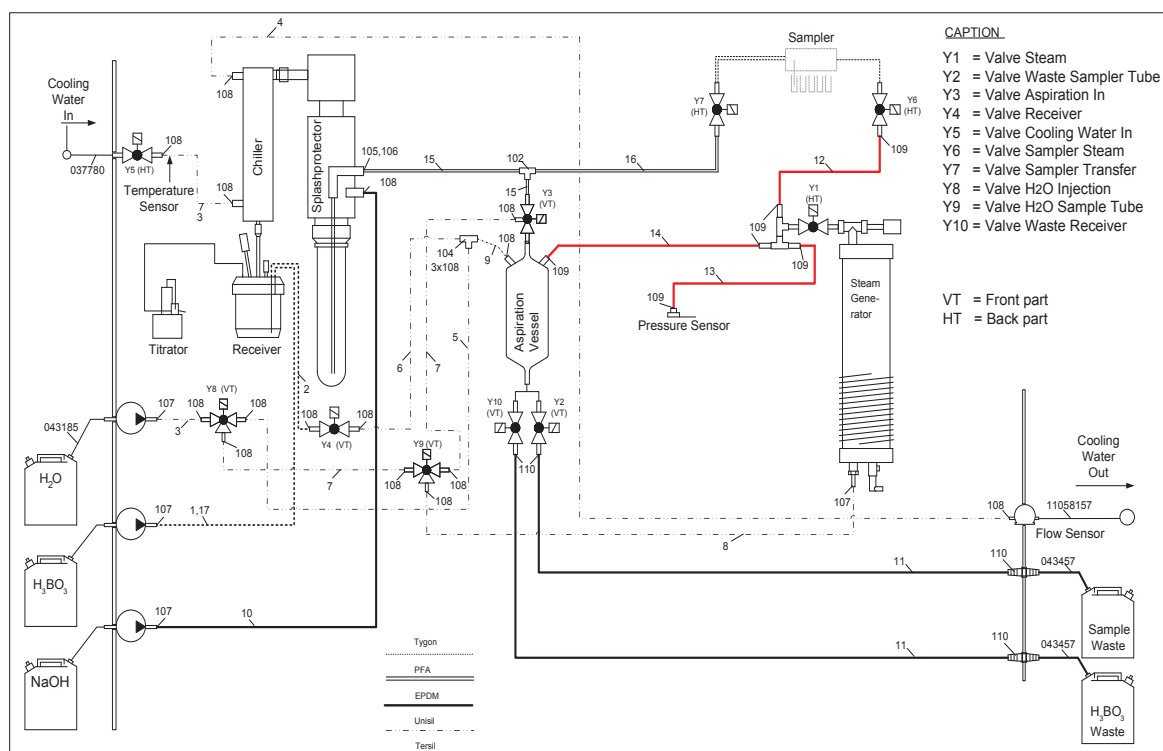

Fig. 10.1: Hosing connection scheme Kjeldahl Sampler System K-375 / K-376 Standard

11 Declarations and requirements

11.1 FCC requirements (for USA and Canada)

English:

This equipment has been tested and found to comply with the limits for a Class A digital device, pursuant to both Part 15 of the FCC Rules and the radio interference regulations of the Canadian Department of Communications. These limits are designed to provide reasonable protection against harmful interference when the equipment is operated in a commercial environment.

This equipment generates, uses and can radiate radio frequency energy and, if not installed and used in accordance with the instruction manual, may cause harmful interference to radio communications. Operation of this equipment in a residential area is likely to cause harmful interference in which case the user will be required to correct the interference at his own expense.

Français:

Cet appareil a été testé et s'est avéré conforme aux limites prévues pour les appareils numériques de classe A et à la partie 15 des réglementations FCC ainsi qu'à la réglementation des interférences radio du Canadian Department of Communications. Ces limites sont destinées à fournir une protection adéquate contre les interférences néfastes lorsque l'appareil est utilisé dans un environnement commercial.

Cet appareil génère, utilise et peut irradier une énergie à fréquence radioélectrique, il est en outre susceptible d'engendrer des interférences avec les communications radio, s'il n'est pas installé et utilisé conformément aux instructions du mode d'emploi. L'utilisation de cet appareil dans les zones résidentielles peut causer des interférences néfastes, auquel cas l'exploitant sera amené à prendre les dispositions utiles pour palier aux interférences à ses propres frais.

BUCHI Affiliates:

Europe

Switzerland/Austria

BÜCHI Labortechnik AG
 CH – 9230 Flawil
 T +41 71 394 63 63
 F +41 71 394 64 64
 buchi@buchi.com
 www.buchi.com

Benelux

BÜCHI Labortechnik GmbH
 Branch Office Benelux
 NL – 3342 GT Hendrik-Ido-Ambacht
 T +31 78 684 94 29
 F +31 78 684 94 30
 benelux@buchi.com
 www.buchi.com/bx-en

France

BUCHI Sarl
 FR – 94656 Rungis Cedex
 T +33 1 56 70 62 50
 F +33 1 46 86 00 31
 france@buchi.com
 www.buchi.com/fr-fr

Germany

BÜCHI Labortechnik GmbH
 DE – 45127 Essen
 T +800 414 0 414 0 (Toll Free)
 T +49 201 747 49 0
 F +49 201 747 49 20
 deutschland@buchi.com
 www.buchi.com/de-de

Italy

BUCHI Italia s.r.l.
 IT – 20010 Cornaredo (MI)
 T +39 02 824 50 11
 F +39 02 575 12 855
 italia@buchi.com
 www.buchi.com/it-it

Russia

BUCHI Russia/CIS
 Russia 127287 Moscow
 T +7 495 36 36 495
 russia@buchi.com
 www.buchi.com/ru-ru

United Kingdom

BUCHI UK Ltd.
 GB – Oldham OL9 9QL
 T +44 161 633 1000
 F +44 161 633 1007
 uk@buchi.com
 www.buchi.com/gb-en

Germany

BÜCHI NIR-Online
 DE – 69190 Walldorf
 T +49 6227 73 26 60
 F +49 6227 73 26 70
 nir-online@buchi.com
 www.nir-online.de

America

Brazil

BUCHI Brasil Ltda.
 BR – Valinhos SP 13271-200
 T +55 19 3849 1201
 F +55 19 3849 2907
 brasil@buchi.com
 www.buchi.com/br-pt

USA/Canada

BUCHI Corporation
 US – New Castle, DE 19720
 T +1 877 692 8244 (Toll Free)
 T +1 302 652 3000
 F +1 302 652 8777
 us-sales@buchi.com
 www.buchi.com/us-en

Asia

China

BUCHI China
 CN – 200233 Shanghai
 T +86 21 6280 3366
 F +86 21 5230 8821
 china@buchi.com
 www.buchi.com/cn-zh

India

BUCHI India Private Ltd.
 IN – Mumbai 400 055
 T +91 22 667 75400
 F +91 22 667 18986
 india@buchi.com
 www.buchi.com/in-en

Indonesia

PT. BUCHI Indonesia
 ID – Tangerang 15321
 T +62 21 537 62 16
 F +62 21 537 62 17
 indonesia@buchi.com
 www.buchi.com/id-in

Japan

Nihon BUCHI K.K.
 JP – Tokyo 110-0008
 T +81 3 3821 4777
 F +81 3 3821 4555
 nihon@buchi.com
 www.buchi.com/jp-ja

Korea

BUCHI Korea Inc.
 KR – Seoul 153-782
 T +82 2 6718 7500
 F +82 2 6718 7599
 korea@buchi.com
 www.buchi.com/kr-ko

Malaysia

BUCHI Malaysia Sdn. Bhd.
 MY – 47301 Petaling Jaya,
 Selangor
 T +60 3 7832 0310
 F +60 3 7832 0309
 malaysia@buchi.com
 www.buchi.com/my-en

Singapore

BUCHI Singapore Pte. Ltd.
 SG – Singapore 609919
 T +65 6565 1175
 F +65 6566 7047
 singapore@buchi.com
 www.buchi.com/sg-en

Thailand

BUCHI (Thailand) Ltd.
 TH – Bangkok 10600
 T +66 2 862 08 51
 F +66 2 862 08 54
 thailand@buchi.com
 www.buchi.com/th-th

BUCHI Support Centers:

South East Asia

BUCHI (Thailand) Ltd.
 TH-Bangkok 10600
 T +66 2 862 08 51
 F +66 2 862 08 54
 bacc@buchi.com
 www.buchi.com/th-th

Middle East

BÜCHI Labortechnik AG
 UAE – Dubai
 T +971 4 313 2860
 F +971 4 313 2861
 middleeast@buchi.com
 www.buchi.com

Latin America

BUCHI Latinoamérica Ltda.
 BR – Valinhos SP 13271-200
 T +55 19 3849 1201
 F +55 19 3849 2907
 latinoamerica@buchi.com
 www.buchi.com/es-es

We are represented by more than 100 distribution partners worldwide.
 Find your local representative at: www.buchi.com