

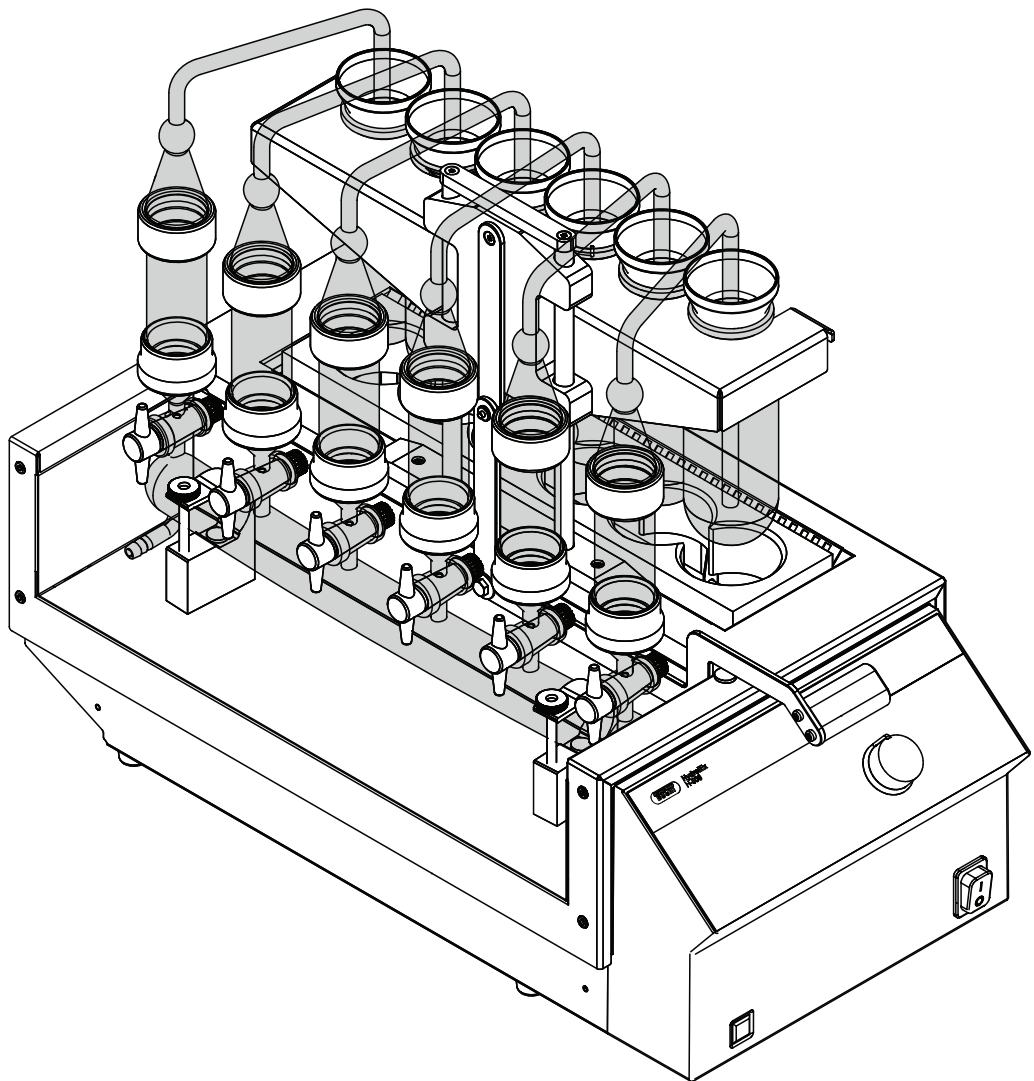

HydroEx H-506

Technical data sheet

The HydroEx H-506 ensures convenient and safe acid hydrolysis for total fat content determination handling six samples simultaneously. The method complies with the standardized methods (Weibull Stoldt, AOAC).



Order Code

Choose the configuration according to your needs:

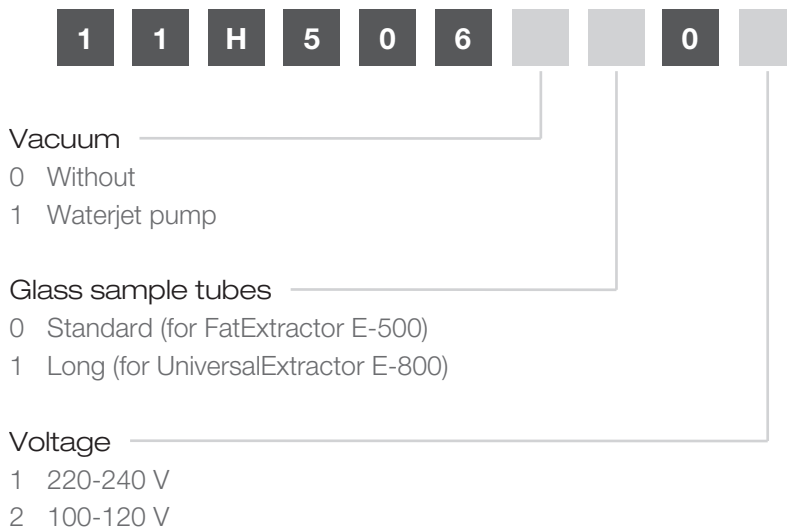

Scope of delivery

All configurations are supplied ready to use.

	HydrolEx H-506 for FatExtractor E-500	HydrolEx H-506 for UniversalExtractor E-800
HydrolEx H-506	1	1
Upper rubber couplings	6	6
Lower rubber couplings bottom	6	6
Glass sample tube with frit	6	-
Glass sample tube with frit, long	-	6
Rinsing funnel	6	6
Sample aspiration tube	6	-
Sample aspiration tube, long	-	6
Suction tube cpl.	1	1
Hydrolysis vessel	6	6
Vacuum hose 2 m	1	1
Quartz sand 2.5 kg	1	1
Power cable	1	1
Operation Manual	1	1

HydroEx H-506

Specification	HydroEx H-506 for 115 V	HydroEx H-506 for 230 V
Dimensions (W x D x H)	312 x 614 x 470 mm	312 x 614 x 470 mm
Minimum clearance (W x D)	200 mm	200 mm
Minimum clearance (H)	300 mm	300 mm
Weight (without glassware)	13 kg	13 kg
Weight (with glassware)	16.5 kg	16.5 kg
Connection voltage	110 - 120 ± 10 % VAC	220 - 240 ± 10 % VAC
Fuse	10 A	10 A
Frequency	50 / 60 Hz	50 / 60 Hz
Overvoltage category	II	II
Protection class	1	1
Pollution degree	2	2
Power consumption	1200 W	1200 W
Temperature range heater	70 - 495 °C	70 - 495 °C
Total Heating power	1200 W	1200 W
Number of hydrolysis positions	6	6
Approvals	CE / CSA	CE / CSA

Ambient conditions

For indoor use only.

Max. altitude above sea level	2000 m
Ambient temperature	5–40 °C
Maximum relative humidity	80% for temperatures up to 31 °C decreasing linearly to 50 % relative humidity at 40 °C
Storage temperature	max. 45 °C

Spare parts

	Order no.	Image
Insulation plate	11065169	
Suction tube, cpl.	11064546	
Set of hydrolysis vessels, 2 pcs.	11064547	
Set of aspiration tubes, 2 pcs.	11064548	
Set of aspiration tubes, long, 2 pcs.	11069475	
Glass sample tubes with frit, 6 pcs. Working volume: 64 mL Filling volume: 82 mL	11067497	
Glass sample tubes LSV with frit, 6 pcs. Working volume: 116 mL Filling volume: 144 mL	11067814	
Glass sample tubes with frit, long, 6 pcs. The glass sample tubes with 150 mm length fit perfectly into the Universal glass extraction chamber. Working volume: 106 mL Filling volume: 123 mL	11067815	
Glass sample tubes with frit LSV, long, 6 pcs. The glass sample tubes with 150 mm length fit perfectly into the Universal LSV glass extraction chamber. Working volume: 180 mL Filling volume: 216 mL	11067816	

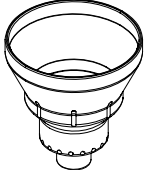
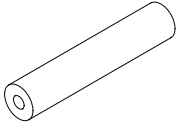
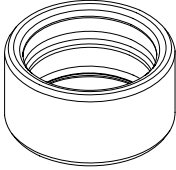
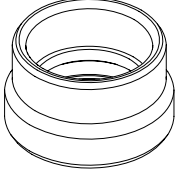
	Order no.	Image
Set of rinsing funnels, 2pcs.	11067582	
Vacuum hose, 2 m	040459	
Set of upper couplings, FKM, 3 pcs.	11068611	
Set of lower couplings, FKM, 3 pcs.	11068612	

Accessories

	Order no.	Image
Water jet pump. Plastic Used when tap water is used to generate vacuum.	002913	
Suction set with pump Vacuum pump V-100, bottle, tubing	11068473	
Holder for glass sample tubes, PTFE	11067220	
Holder for glass sample tubes, stainless steel	11067219	

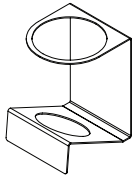
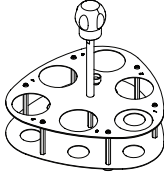
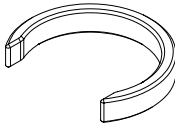
	Order no.	Image
Weighing support for hydrolysis vessels	11067040	
Hydrolysis vessel carrier	11067492	
<p>Adapter clips for B-411 sample tubes, 4 pcs.</p> <p>These adapters allow the use of glass sample tubes for B-411/ B-811 on combination with the HydrolEx H-506. In addition the rubber couplings of the E-416 / B-411 are needed for the use in the H-506. EPDM (037381) or Viton (044491)</p>	11069239	

Consumables

	Order no.
Quartz sand 0.3 - 0.9 mm, 2.5 kg	037689
Celite® 545, 1 kg	11068920
Quartz sand (25 kg)	034925